

bicon[®]
DENTAL IMPLANTS



SHORT[®]
IMPLANTS



INTRODUCTORY
SURGICAL MANUAL





bicon[®]
DENTAL IMPLANTS

 **SHORT**[®]
IMPLANTS

 **NARROW**[™]
IMPLANTS

MAX 2.5[™]
MAXILLARY ANTERIOR IMPLANTS

SynthoGraft[®]
Pure Phase Beta-Tricalcium Phosphate

 **TRINIA**[™]

INTRODUCTORY
SURGICAL MANUAL

Table of Contents

THE BICON DESIGN	1-2
TREATMENT PLANNING	3-8
Anatomic Sites	3
Mandible and Maxilla	4
Bone Classification	5
Implant Size Selection	6
Surgical Templates	7-8
INSTRUMENTATION	9-18
Comprehensive Surgical Kit	9-10
Advanced Surgical Kit	11
Introductory Surgical Kit	12
Guided Kits	12
Restorative Kit	13-14
Pilot Drills	15
Latch Reamers	16
Hand Reamers	17
Threaded Instrumentation Interchangeability	18
IMPLANT BASICS	19-20
Implant Packaging	19
Removing Implant from Packaging	20
Transporting Implant to Osteotomy	20
TECHNIQUES	21-29
Two-Stage Surgery	21-23
Implant-level Impressions	24
One-Stage Surgery	25-26
Two-Stage Guided Surgery	27-28
Immediate Implant Placement	29
SURGICAL TIPS	30
Reaming on a Slope	30
Drilling in a Maxillary Anterior Extraction Site	30

THE BICON DESIGN was created in 1985 not as a research project to study osseointegration, but rather as a means to restore dentition.

Bicon is different — but **different by design**.

The different shape, different geometry, and different surgical protocols lead to different clinical capabilities and different long-term results.

The design has remained consistent and unchanged since 1985, and has truly passed the test of time.

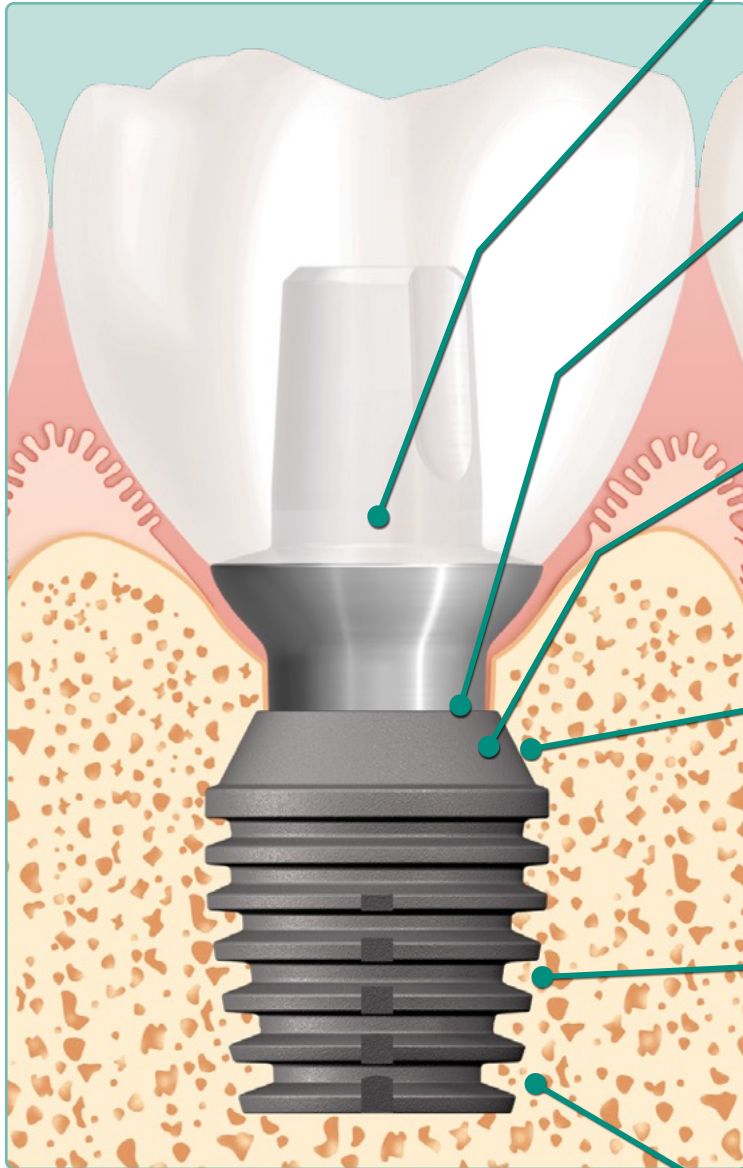

Scannable Temporary Abutments allow the clinician to fabricate the prosthesis while the implant is integrating.



The 1.5° locking taper with no screws allows for 360° abutment positioning, extraoral cementation, and CAD/CAM restorations with superior aesthetics. No screws results in less maintenance.



The 1.5° locking taper allows for subcrestal implant placement and eliminates the bacterial flux present in threaded implants with screw components. Note the lack of inflammation after 10 years when the abutment is removed.

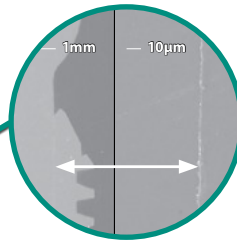

The 1.5° locking taper connection provides a seal at the implant to abutment interface, avoiding the microbial leakage issues that can result in inflammation.

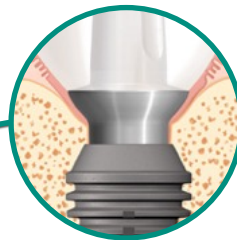

The sloping shoulder and subcrestal implant placement provides more room for bone over the implant, a sensible narrow emergence, and support for papillae.

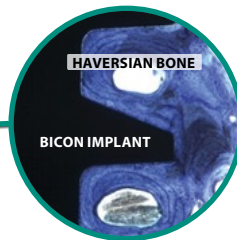

The fins and plateaus offer at least 30% more surface area than a threaded implant of the same dimensions and provides for the callus formation of haversian bone between the fins of the implant, which allows for shorter implants.



Slow-speed drilling without irrigation is more convenient for clinician and patient alike, and allows for autogenous bone harvesting.

BICON IS A TIME-PROVEN SOLUTION

DESIGN

- Fins and plateaus
- Sloping shoulder
- Narrow emergence
- 1.5° locking taper
 - No screws
- Solid abutments
- Hemispherical base



PROTOCOLS

- Slow-speed drilling
- Autogenous bone harvesting
- Subcrestal implant placement
- 360° abutment positioning
 - Simple techniques
- Scannable Temporary Abutments



CAPABILITIES

- Avoid grafting
- Haversian bone
- Shorter implants
- Support for papillae
- Lack of inflammation
- Extraoral cementation
- Fabricate prosthesis during implant integration



RESULTS

- Bone gain
- Superior aesthetics
- Patient acceptance
- Reduced costs
- Less maintenance
- Fewer appointments
 - Saved time
 - More referrals

"The Bicon Dental Implant System is fabulous. Its simplicity and decreased costs have pleased our referring dentists and their patients. Consequently, our implant case load has improved dramatically."

Robert S. Johnson | Oral and Maxillofacial Surgeon • St. Petersburg, FL • 2009

REAL-WORLD RESULTS WITH BICON IMPLANTS

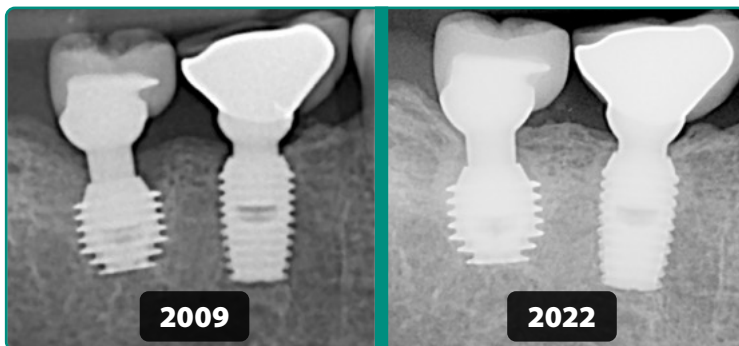

Bicon implants can often GAIN bone, while threaded implant systems routinely lose bone over time.

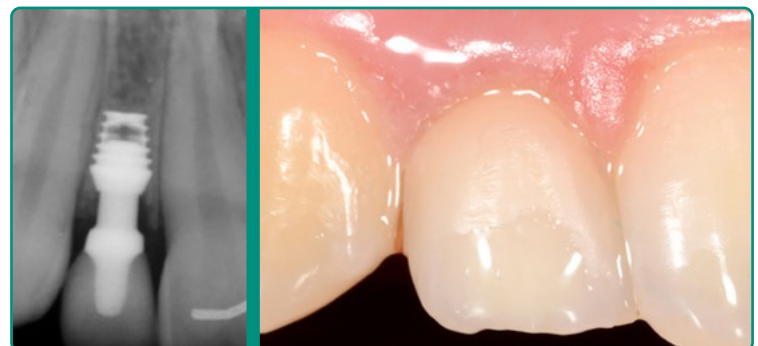

Bicon's sloping shoulder provides room for bone to support interdental papillae resulting in gingival aesthetics that last.

SELECTED RESEARCH

Cheng, Y-C., Ewers, R., Morgan, K., Hirayama, M., Murcko, L., Morgan, J., Edmara, T., Bergamo, P., Bonfante, E., [Antiresorptive Therapy and Dental Implant Survival: An up to 20-Year Retrospective Cohort Study in Women](#), Clinical Oral Investigations, August 2022

Urdaneta, R.A., Daher, S., Leary, J., Emanuel, K., Chuang, S.K., [The Survival of Ultrashort Locking-Taper Implants](#), Int J Oral Maxillofac Implants, 2012 May/June; 27(3):644-654

Urdaneta, R.A., Daher, S., Leary, J., Emanuel, K., Chuang, S.K., Tovar, L.A., [Factors Associated with Crestal Bone Gain on Single-Tooth Locking-Taper Implants: The Effect of NSAIDs](#), Int J Oral Maxillofac Implants, 2011 September/October; 26(5):1063-1078

Birdi, H., Schulte, J., Kovacs, A., Weed, M., Chuang, SK, [Crown-to-Implant Ratios of Short-Length Implants](#), J Oral Implantol, 2010; 36(6):425-433

Urdaneta, R., Rodriguez, S., McNeil, C., Weed, M., and Chuang, S., [The Effect of Increased Crown-to-Implant Ratio on Single-Tooth Locking-Taper Implants](#), Int J Oral Maxillofac Implants, 2010 July/August; 25(4):729-743

Venuleo, C., Chuang, S.K., Weed, M., Dibart, S., [Long Term Bone Level Stability on SHORT® Implants: A Radiographic Follow up Study](#), Indian Journal of Maxillofacial and Oral Surgery, 2008 September; 7(3):340-345.

Schulte, J., Flores, A., and Weed, M., [Crown-to-Implant Ratios of Single Tooth Implant-Supported Restorations](#), J Prosthet Dent, 2007 July; 98(1):1-5

Gentile, M., Chuang, S.K., and Dodson, T., [Survival Estimates and Risk Factors for Failure with 6.0 x 5.7mm Implants](#), Int J Oral Maxillofac Implants, 2005 November/December; 20(6):930-937

Bozkaya, D., Müftü, S., and Muftu, A., [Evaluation of Load Transfer Characteristics of Five Different Implant Systems in Compact Bone at Different Load Levels by Finite Element Analysis](#), J Prosthet Dent, 2004 December; 92(6):523-530



THE BICON SHORT IMPLANT

A THIRTY-YEAR PERSPECTIVE

ISBN: 978-0-86715-781-9

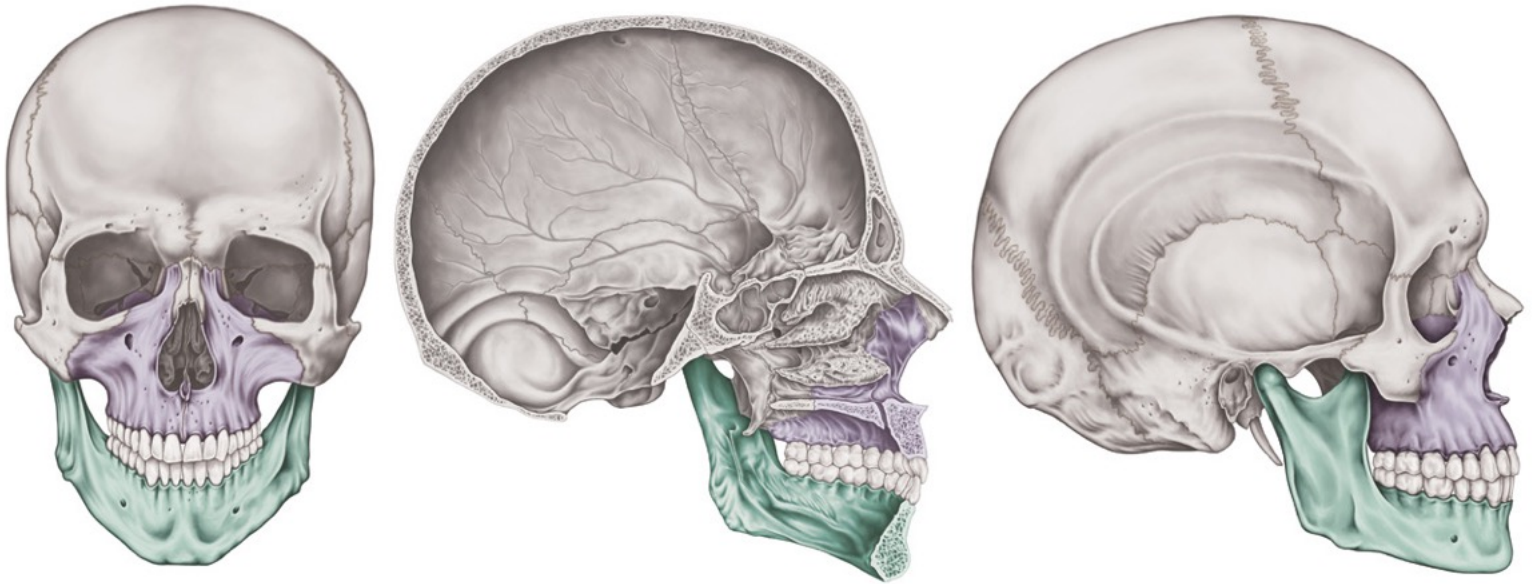

Implant dentistry is a prosthetic treatment with a surgical component:

The anatomic limitations, positioning, and trajectory of the intended implant, as well as the functional and aesthetic needs of the intended prosthesis, must be clearly understood — **prior to the subcrestal placement of the implant.**

Therefore, it is paramount for a clinician to not only have a comfortable, practical knowledge of oral anatomy but also to precisely identify the relative anatomic sites and conditions of each patient via radiographic or CBCT imaging and clinical observation.

It is essential to identify the following anatomic sites and patient conditions before initiating any surgery:

Anatomic Sites:

- Size and shape of alveolar ridge and palatal vault
- Floor and septa of maxillary and nasal sinuses
- Incisive foramen
- Path of inferior alveolar and mental nerves
- Mylohyoid line and submandibular fossa
- Sublingual fossa with its sublingual artery

Patient Conditions:

- Height of the inter occlusal freeway space
- Edentulous space
- Anatomic relationship between the mandible and maxilla (Class I, Class II, Class III)
- Bone pathology or resorption
- Quality and quantity of mucosa
- Medical history and status

- Examine patient with mouth closed to ascertain if there is enough inter-occlusal space for the intended prosthesis.
- A frenectomy or alveolectomy may be advisable to improve the surgical site.
- Radiographically visualize maxillary sinus, nasal floor, and inferior alveolar nerve relative to the intended site.
- Although usually not necessary, Cone Beam Computed Tomography (CBCT) can be of value in determining the feasibility of an implant site — especially where there is minimal bone and/or concern as to the exact location of anatomic structures.



Note: Relation of the intended prosthesis to the bone that will support it

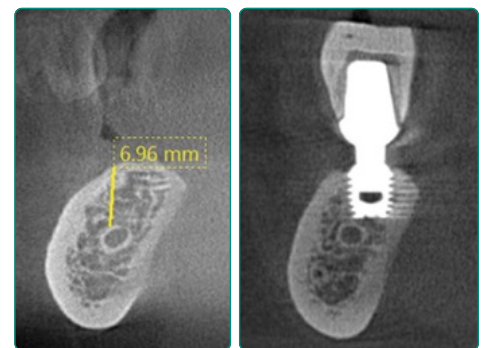

Cone Beam Computed Tomography (CBCT)

TREATMENT PLANNING MANDIBLE AND MAXILLA

Anatomic Sites of Concern in the Mandible

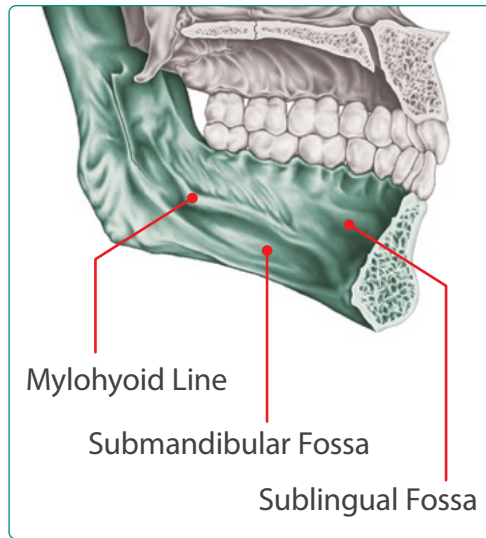
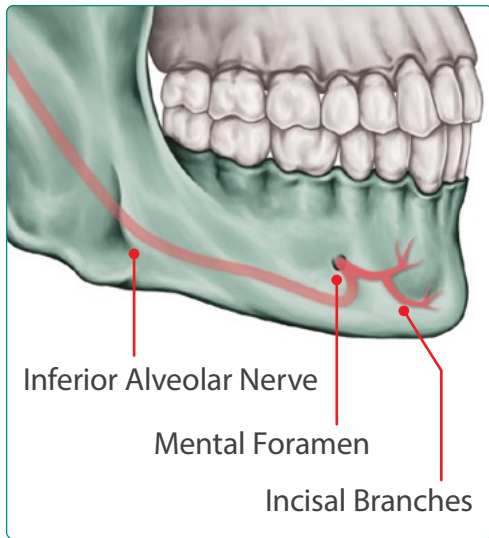

Care must be taken to avoid the inferior alveolar nerve and the mental foramina in the premolar region, since the mandibular nerve is often coronally inclined in this area.

Care must be taken to avoid the penetration of the submandibular fossa which is located below the mylohyoid line, and especially the sublingual space with the sublingual artery in the anterior mandible. Inadvertent penetration may be avoided by appropriately directing the pilot drill and reamers toward the buccal and monitoring the area with finger pressure while drilling.

In general, 2.0mm of bone should separate the apex of the implant osteotomy and the mandibular canal.

Anatomic Sites of Concern in the Maxilla

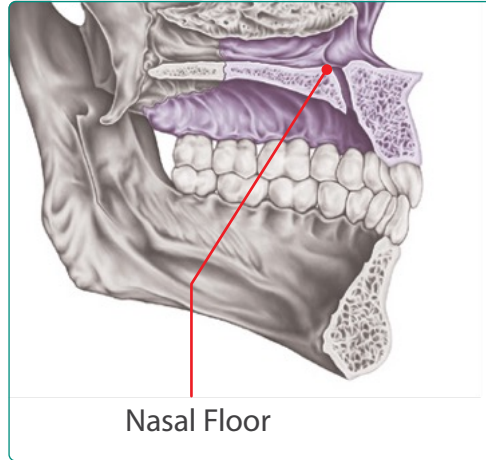
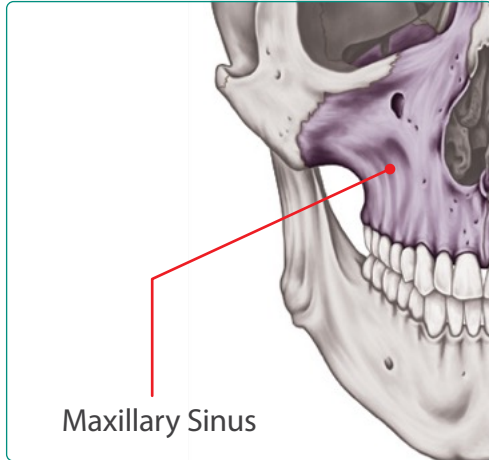

The location of the maxillary sinus, nasal floor, and incisive foramen must be positively identified to avoid the inadvertent penetration with a reamer or an implant.

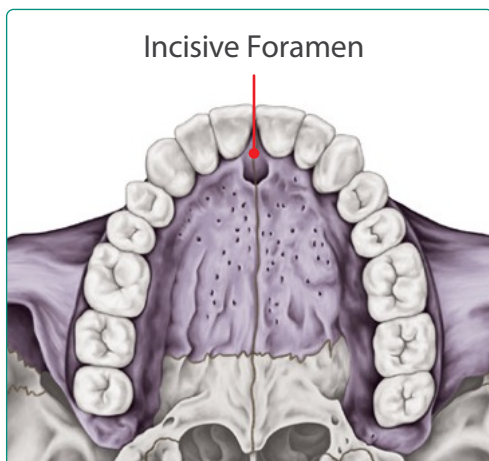

BONE TYPE

DESCRIPTION

INTEGRATION TIME



TYPE I

DENSE CORTICAL

Flute of a 3.5mm reamer bur filled with bone and minimal blood

**MINIMUM OF
4 MONTHS**



TYPE II

**POROUS CORTICAL
AND COARSE TRABECULAR**

Flute of a 3.5mm reamer bur filled with blood wetted bone

**MINIMUM OF
3 MONTHS**

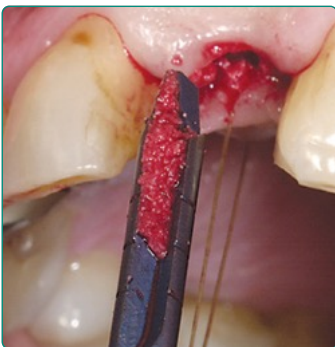

TYPE III

**POROUS CORTICAL
AND FINE TRABECULAR**

Flute of a 3.5mm reamer bur only partially filled with blood wetted bone

**MINIMUM OF
3 MONTHS**



TYPE IV

FINE TRABECULAR

Flute of a 3.5mm reamer bur devoid of bone

**MINIMUM OF
4-5 MONTHS**

GRAFT

SYNTHETIC

Inorganic material, such as SynthoGraft® (beta tricalcium phosphate)

TREATMENT PLANNING IMPLANT SIZE SELECTION

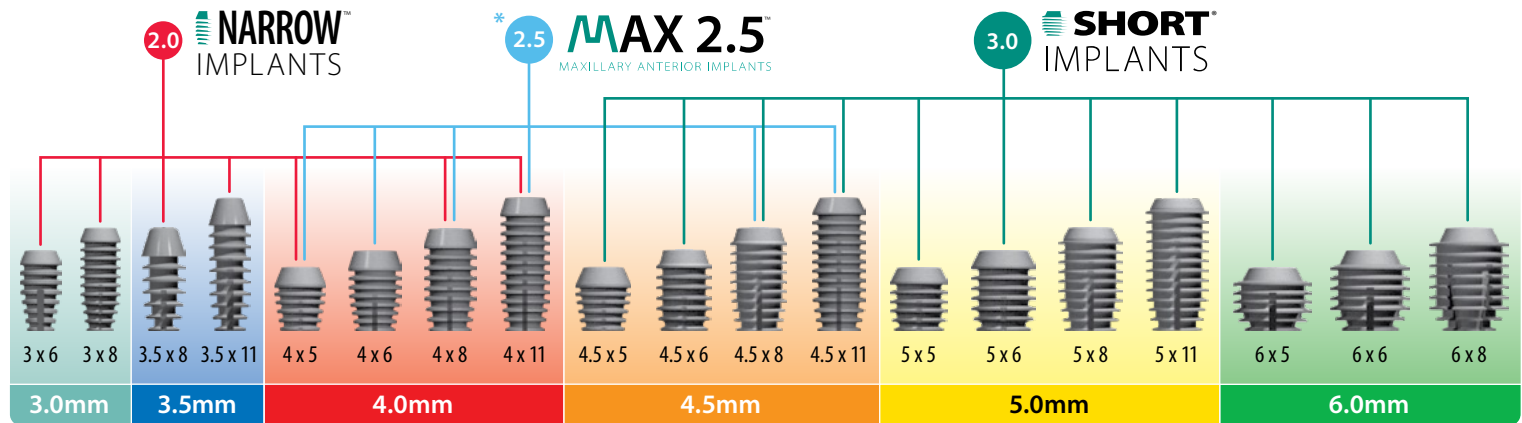
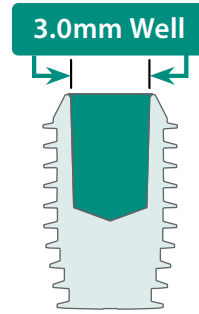
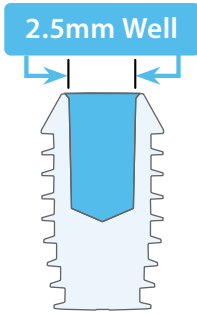
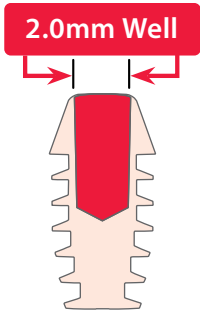

MAXILLA

MANDIBLE

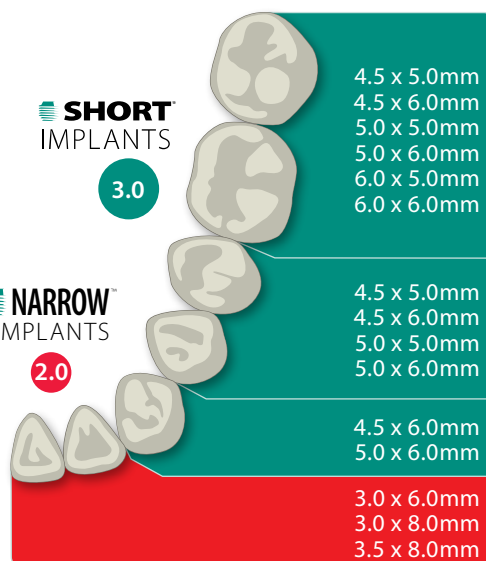
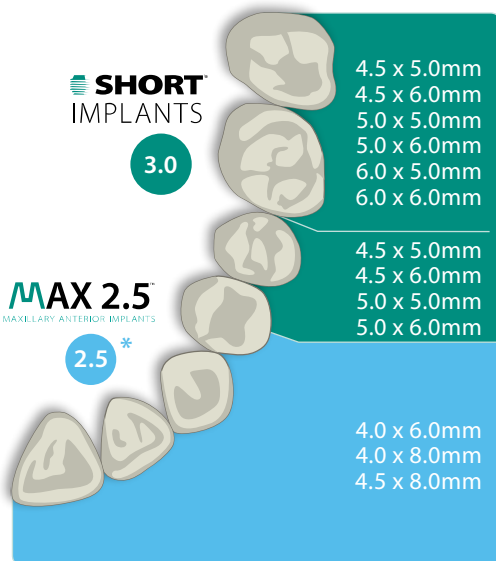

IMPLANT SIZE RECOMMENDATIONS

The adjacent charts contain **recommended implant sizes** only. Actual clinical conditions and the clinician's assessment of the patient should be the main criteria for choosing the size of an implant for a particular area.

In general, it is better to use a 5.0mm SHORT® Implant than a longer length so that the implant may be positioned 2.0 to 3.0mm below the alveolar crest.

The width of the alveolar bone may be assessed with a CBCT scan, periodontal probe, or caliper. It is advisable to have 1.0mm of bone surrounding an implant for a long-term favorable prognosis.

NOTE: 2.5mm well implants have been designed exclusively for maxillary anterior single-unit restorations. For any other restoration, including maxillary anterior splinted prostheses, overdentures, or fixed-removable applications, it is strongly recommended to avoid 2.5mm well implants.

In posterior sites, the 2.5mm post abutments may be too retentive and not easily removed.

For maxillary anterior implants, anticipate the need for bone grafting or ridge splitting techniques.

NOTE: The 3.0 and 3.5mm diameter implants are generally for mandibular anterior teeth. If practical, their use should be avoided for maxillary anterior and all posterior teeth.

It is advisable to have at least 1.0mm of bone around the implant. Therefore, an advisable bone width of 5.5mm is necessary to comfortably accommodate a 3.5mm implant, unless ridge splitting or grafting techniques are employed to widen the site.

SURGICAL TEMPLATES

Implant dentistry is a prosthetic treatment with a surgical component. Accurate placement of an implant requires the awareness of its intended prosthetic restoration. Surgical guides should efficiently facilitate the placement of the implant within bone so that its abutment is positioned in the middle of the intended prosthetic tooth. Mounted study models and a diagnostic wax-up of the teeth to be replaced are usually necessary for the fabrication of a template for multiple implant placements.

Although the location and availability of bone shall dictate the ultimate trajectory of the pilot drill, clinicians should strive to stay within the center of the intended tooth and within 10 degrees of the trajectory of the intended prosthesis.

Using the adjacent teeth as a guide is a simple way of appropriately positioning the pilot drill for single implant placements. Position the pilot drill in the middle of the edentulous space and parallel to the adjacent teeth. To avoid a parallax issue, it may be helpful to view the positioning of the pilot drill from both sides of the patient, prior to drilling.

Vacuum-Formed Template

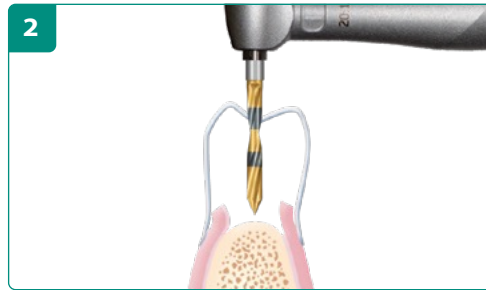
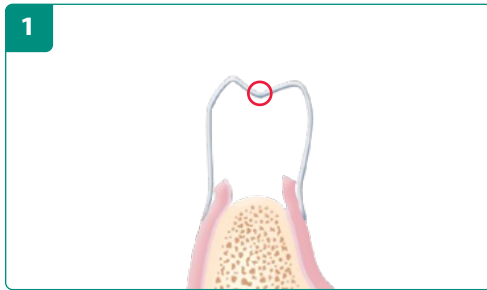

Placing the pilot drill through a perforation in the center of a tooth of a vacuum-formed plastic template facilitates its appropriate positioning for multiple implants.

Template from Stone Model

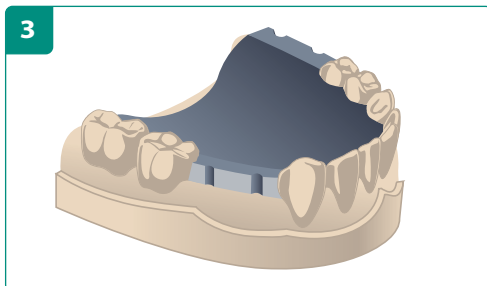
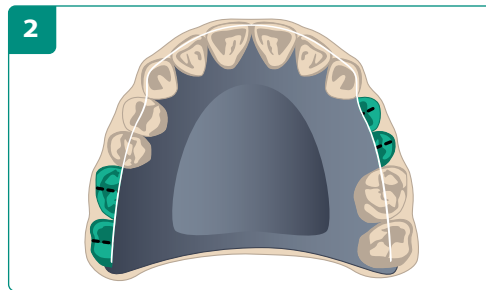
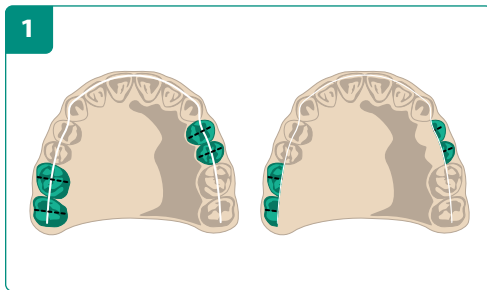

KEYS TO SUCCESS

- The trajectory of the pilot drill will be the trajectory of the implant and the trajectory of a straight abutment.
- The final implant osteotomy, to the extent possible, should be centered in the middle of the intended prosthetic tooth.
- An appropriate mesio-distal positioning of a pilot osteotomy is more critical than a slightly off-axis trajectory.
- Stabilize the template on adjacent teeth, alveolar, and palate or alternatively with screws.

1. After making an impression and subsequent cast of the diagnostic wax-up of the intended restoration, a vacuum-formed template is prepared on the cast from thin template stock which is commonly used for the chairside fabrication of transitional restorations.
2. Drill a hole in the middle of the incisal or occlusal surface of the template in the location of the intended tooth. If possible, trim the template to include at least one tooth distal and three or four teeth mesial to the area of the intended replacement.

1. Using a duplicated stone model of the diagnostic wax-up, draw a line through the incisal edge and occlusal surfaces of the teeth and another line in the center of each tooth to be replaced, intersecting the incisal or occlusal line. Remove the lingual half of the teeth to be replaced.
2. Fabricate a guide by molding acrylic onto the lingual aspect of the model up to the level of the central fossa or incisal edge of the teeth to be restored.
3. Cut a 2.5mm wide groove in the acrylic corresponding to the middle of each intended tooth to be replaced.
- A. OPTION: Alternatively, digitally scan the dentition or stone model and create the template via a CAD/CAM workflow with either milling or 3D printing techniques.

Template from Existing Prosthesis

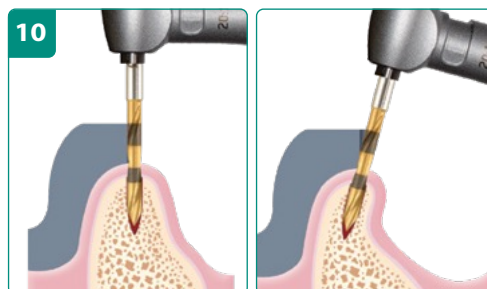
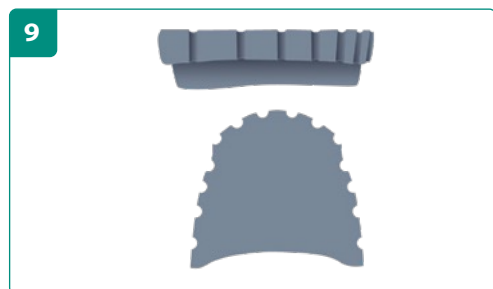
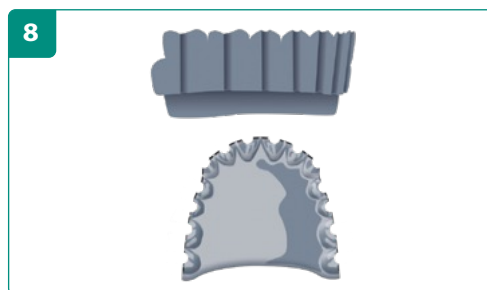
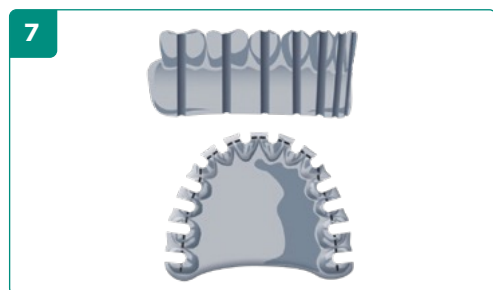
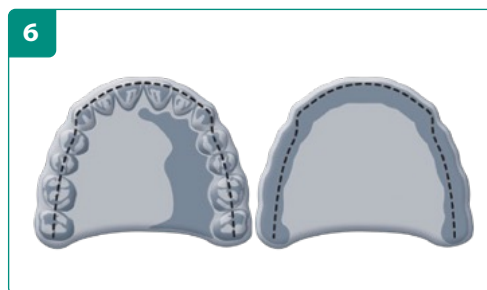
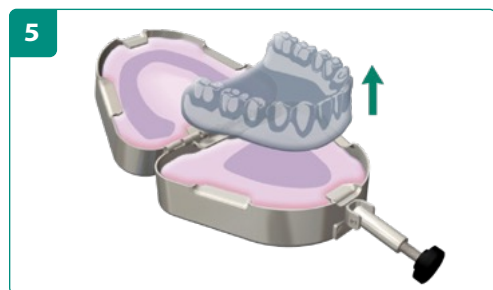
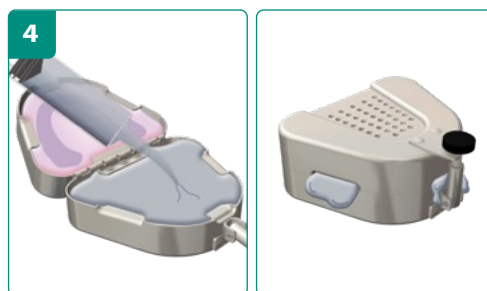
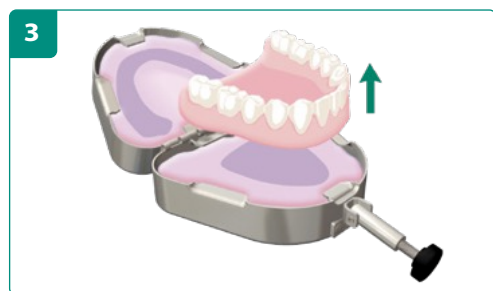
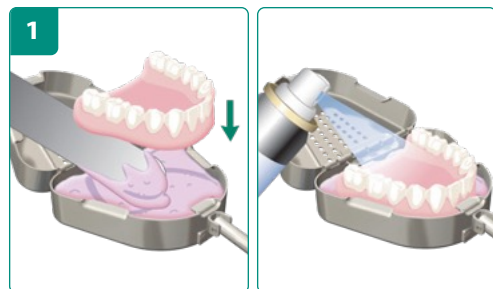

For larger edentulous areas, fabricate a template by using an existing removable prosthesis. When fabricating the template, the buccal aspect is inclined from the incisal edge or central fossa of the teeth back to the crest of the alveolar ridge, which is represented on a duplicated prosthesis as the greatest concavity on the alveolar ridge side of the prosthesis.

1. Insert denture into impression material in denture duplicator and apply separating medium.
2. Fill other side with impression material, close, and allow impression material to set.
3. Open and remove denture.
4. Fill impression material mold with acrylic, close, and allow acrylic to set.
5. Open and remove duplicated denture.
6. Draw a line in the middle of each tooth and a line representing greatest concavity on the tissue side.
7. Cut a 2.5mm wide groove in center of each tooth joining the lines representing the middle of each tooth and greatest concavity of the tissue side.
8. Remove the buccal acrylic along the slope joining the two lines representing the middle of each tooth and greatest concavity of the tissue side.
9. Trim excess incisal length to prevent interference with head of handpiece.
10. The template determines mesio-distal positioning. Availability of bone determines final bucco-lingual angulation.

NOTE: Alternatively, digitally scan the prosthesis and create the template via a CAD/CAM workflow with either milling or 3D printing techniques. See example on Page 7, Step A.

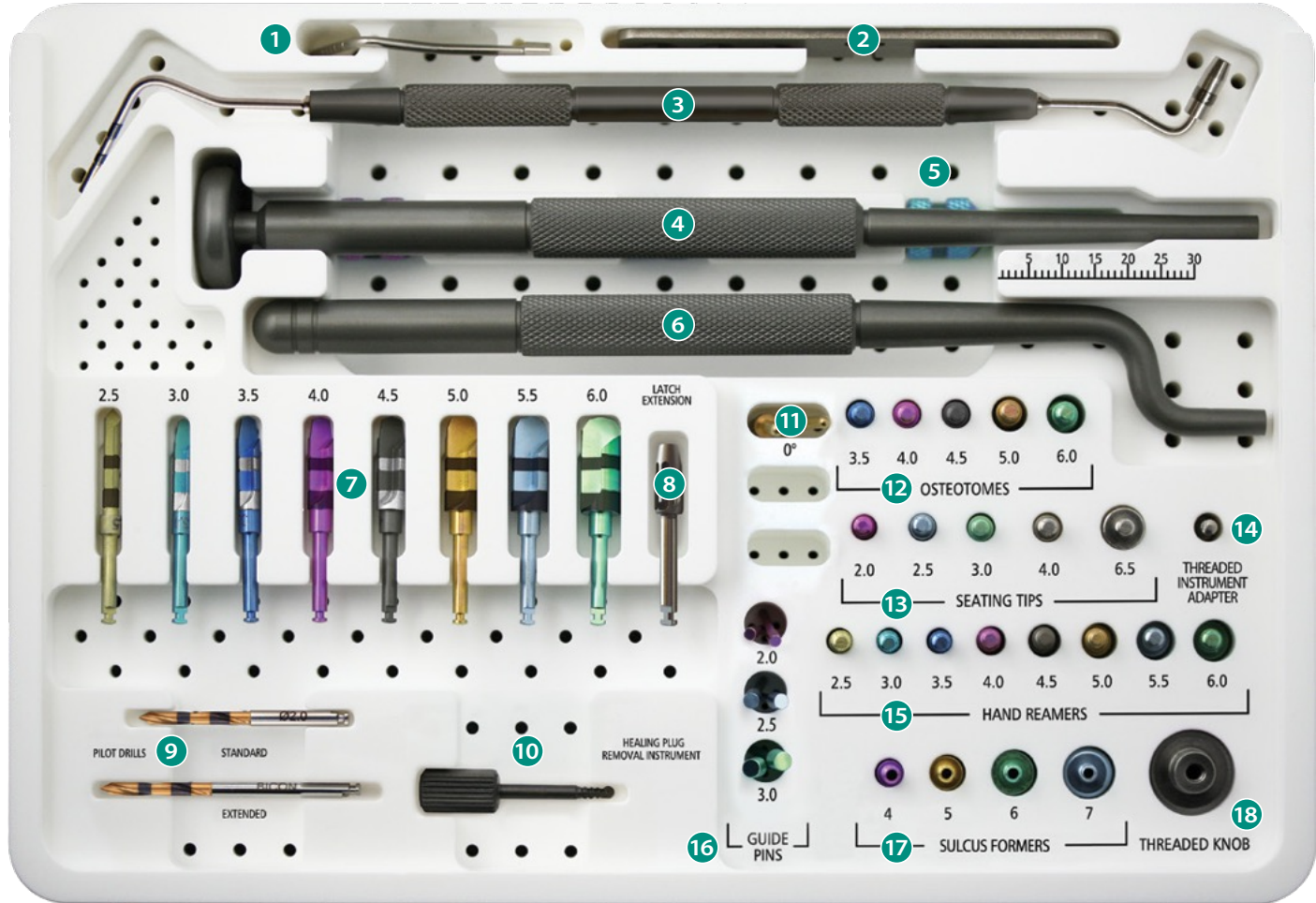

COMPREHENSIVE SURGICAL KIT (260-101-098)

- 1 Shoulder Depth Gauge**
Designed to be used with the Double-Ended Instrument Holder to facilitate selecting the proper abutment height.
- 2 Removal Wrench**
Designed to unfasten hand reamers, osteotomes, chisels and bone expanders from a threaded straight handle, threaded offset handle, or a threaded knob.
- 3 Double-Ended Osteotomy Depth Gauge**
Designed to facilitate the measuring of an osteotomy's depth.
- 4 Threaded Straight Handle**
Designed to be used with all threaded instrumentation: hand reamers, sulcus formers, inserters/retrievers, tissue punches, osteotomes, chisels, bone expanders, and seating tips.
- 5 Implant Inserters / Retrievers**
Designed to be used with either a threaded knob or a threaded straight handle to assist in the placement and retrieval of implants depending upon the clinical situation. It is essential for a clinician to understand how an implant is disengaged from the inserter/retriever instrument prior to using it intraorally. See Page 20.
- 6 Threaded Offset Handle**
Designed to be used with implant and abutment seating tips when direct access is not practical.
- 7 Latch Reamers**
Designed to prepare an osteotomy without irrigation at a maximum speed of 50RPM and to harvest autogenous bone for grafting. Markings are positioned at 6.0, 8.0, 11.0, and 14.0mm. Extended latch reamers are also available to accommodate clinical situations.



8 Latch Reamer Extension

Designed to extend a latch reamer to facilitate access when adjacent teeth interfere with the handpiece. If the latch reamer is not fully engaged in the latch extension prior to being used, the latch reamer may become jammed or damaged.



9 Pilot Drills

Designed to prepare the initial pilot osteotomy at 1,100 RPM and to establish the osteotomy's trajectory. Available in two lengths. Markings are positioned at 6.0, 8.0, 11.0, and 14.0mm.



10 Healing Plug Removal Instrument

Designed to facilitate the removal of the previously cut black healing plug from the implant's well during the second stage surgical procedure.



11 Paralleling Pin

Designed as an aid to correctly align pilot osteotomies and implants. For multiple implant placements, they may be stepped from the initial osteotomy to the subsequent osteotomies so that the pilot drill can be aligned parallel to the Paralleling Pin.



12 Osteotomes

Designed to be fastened to either a threaded straight handle or an offset handle and are used to prepare an osteotomy, especially for internal sinus lift procedures and ridge expansions. Available in diameters corresponding to implant diameters.



13 Implant / Abutment Seating Tips

Designed for use with a threaded straight or offset handle to facilitate the correct seating of an implant or abutment. When using the implant seating tips, it is imperative that the seating tips be fully seated to the bottom of the implant's well.



14 Threaded Instrument Adapter

Designed to be fastened to hand reamers and sulcus formers, allowing them to be attached to a latch contra-angle handpiece.



15 Hand Reamers

Designed to be fastened to a threaded straight handle to manually prepare an osteotomy. They can also be attached to a Threaded Instrument Adapter for use with a latch contra-angle handpiece.



16 Standard Guide Pins

Designed to be used as a guide for the sulcus formers. They are available in three sizes corresponding to the diameters of the internal connections of Bicon's implants. They may also be used to assess the trajectory of an implant in addition to examining how well an implant has osseointegrated. **NOTE:** Guide Pins – Tall Post are available for deeply-positioned implants which require long post abutments.



17 Sulcus Formers

Designed to remove any soft tissue or bone above the implant that could prevent the correct engagement of the abutment's locking taper connection to the implant. They are used in conjunction with the guide pins in #16 above. They are available in diameters consistent with the hemispherical base of the intended abutment.



18 Threaded Knob

Designed to be used with threaded instrumentation (sulcus formers, inserters/retrievers, tissue punches, and hand reamers) where there is limited access.



Surgical Mallet (Not depicted in kit picture)

Used along with other instruments to facilitate applying the appropriate force for seating an abutment into the well of an implant, or an implant into an osteotomy. The mallet is also used with other instruments such as bone expanders or chisels.



Silicone Dappen Dish (Not depicted in kit picture)

Designed to hold harvested autogenous bone and synthetic bone grafting material.



Healing Plug Cutter (Not depicted in kit picture)

Designed to score a healing plug intraorally at the level of bone and to cut the plug either intra or extraorally.



NOTE: The instrument tray may be sterilized at temperatures up to 273° F (134° C).



ADVANCED SURGICAL KIT (260-101-095)

Bicon's Advanced Surgical Kit contains all of the instruments in the Comprehensive Surgical Kit, plus the following:

- 1 Shoulder Depth Gauge with Double-Ended Instrument Holder**
Designed to facilitate selecting the proper abutment height.
- 2 Silicone Dappen Dish**
Designed to hold harvested autogenous bone and synthetic bone grafting material.
- 3 Bone Expanders**
Designed to be fastened to threaded handles to facilitate the preparation of an osteotomy, especially for internal sinus lift procedures and ridge expansions.
- 4 Expanding Chisels**
Designed to be fastened to threaded handles to facilitate the preparation of an osteotomy with a ridge expansion.
- 5 Extended Latch Reamers**
Designed to facilitate access when adjacent teeth interfere with the handpiece while offering the convenience of not having to use a latch reamer extension. Markings are positioned at 6.0, 8.0, 11.0, and 14.0mm.



NOTE: The instrument tray may be sterilized at temperatures up to 273° F (134° C).

INTRODUCTORY SURGICAL KIT & GUIDED KITS

INTRODUCTORY SURGICAL KIT (260-101-057)

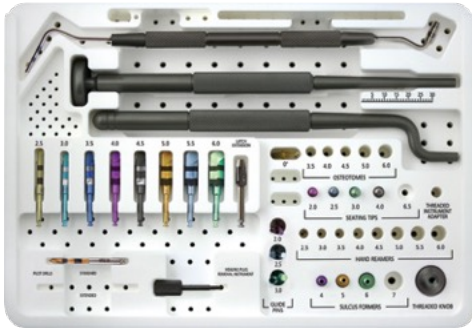

Bicon's Introductory Surgical Kit contains all of the instruments in the Comprehensive Surgical Kit, except for the following:

- Shoulder Depth Gauge
- Removal Wrench
- Implant Inserters / Retrievers
- Extended Pilot Drill
- Osteotomes
- 6.5mm Seating Tip
- Threaded Instrument Adapter
- Hand Reamers
- 7 Series Sulcus Former
- Healing Plug Cutter

Guided

PILOT DRILL STOP KIT (260-101-099)



When the anatomy permits, Bicon's 2.0mm diameter Pilot Drill Stop Kit allows experienced and novice clinicians alike to confidently drill a 2.0mm pilot osteotomy to a precise depth. The drills are Stainless steel with a titanium-nitride coated tip, and are offered with seven incremental stops ranging from 5.0mm–11.0mm.

GUIDED SURGERY KITS AND GUIDE RINGS



2.0mm Guided Pilot Drill Kit
260-101-820



Guide Rings (not included with kits)

Designed for guided placement of an implant of a specific diameter using a CAD/CAM fabricated surgical guide with a titanium guide ring. Note that guided surgery is often not practical due to the lack of available bone. Using only a pilot drill with either a CAD/CAM fabricated or traditional Bicon custom guide can be more beneficial, since their use provide for ridge widening and internal sinus lift procedures.

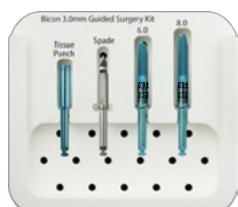

3.0mm Guided Surgery Kit
260-101-830

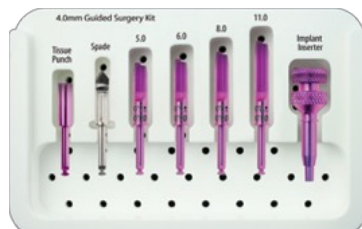

4.0mm Guided Surgery Kit
260-101-840

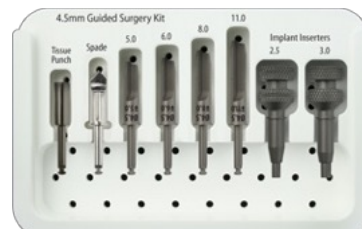

4.5mm Guided Surgery Kit
260-101-845



5.0mm Guided Surgery Kit
260-101-850



RESTORATIVE KIT (260-101-096)

- 1 Instrument Holder**
Designed with a threaded end for fastening the 2.0 and 2.5mm Abutment Prep Holder Tips and any threaded instrument. Its locking taper end is designed to hold a 3.0mm post abutment or the Shoulder Depth Gauge.
- 2 Shoulder Depth Gauge**
Designed to facilitate selecting an appropriate abutment height. It may be attached to the locking taper end of the Instrument Holder.
- 3 Threaded Straight Handle**
Designed to be used with all threaded instrumentation: hand reamers, sulcus formers, inserters/retrievers, tissue punches, osteotomes, chisels, bone expanders, and seating tips.
- 4 Threaded Offset Handle**
Designed to be used with implant and abutment seating tips when direct access is not possible.
- 5 Healing Plug Removal Instrument**
Designed to facilitate the removal of the previously cut black healing plug from the implant's well during the second stage surgical procedure.
- 6 2.0mm Implant/Angled Abutment Seating Tip**
Designed for use with a threaded straight or offset handle to facilitate the correct seating of an implant or an abutment.

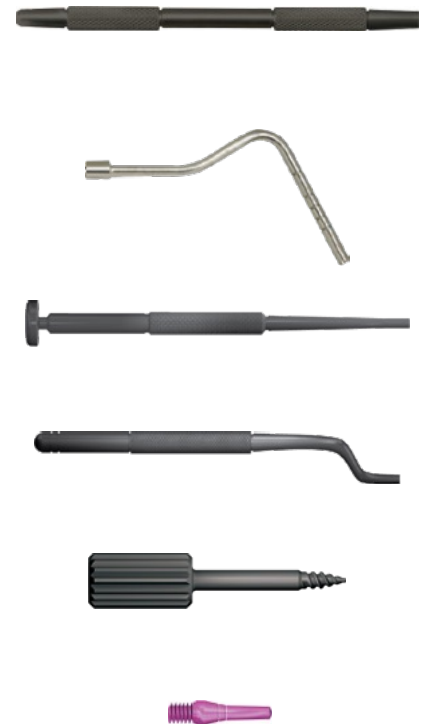

7 Standard Abutment Seating Tip

Designed for use with a threaded straight or offset handle to facilitate the correct seating of an abutment.



8 Large Abutment Seating Tip

Designed for use with a threaded straight or offset handle to facilitate the correct seating of an abutment.



9 Crown Seating Tip

Designed for use with a threaded straight or offset handle and a custom thermoplastic seating jig to facilitate directing the seating forces in the long axis of the implant well for an extraorally cemented crown.



10 Abutment Prep Holder Tips

Designed to be fastened to the instrument holder for securing a 2.0 or 2.5mm post abutment while it is being modified. The holes facilitate the removal of the seated abutment from the tip by placing an instrument through the hole and lifting.



11 Standard Guide Pins

Designed to be used as a guide for the sulcus formers. They are available in three sizes corresponding to the diameters of the internal connections of Bicon's implants. They may also be used to assess the trajectory of an implant in addition to examining how well an implant has osseointegrated. **NOTE:** Guide Pins – Tall Post are available for deeply-positioned implants which require long post abutments.



12 Sulcus Formers

Designed to remove any soft tissue or bone above the implant that could prevent the correct engagement of the abutment's locking taper connection to the implant. They are used in conjunction with the guide pins in #11 above. They are available in diameters consistent with the hemispherical base of the intended abutment.

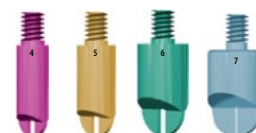

13 Threaded Knob

Designed to be used with threaded instrumentation (sulcus formers, inserters/retrievers, tissue punches, and hand reamers) where there is limited access.



Surgical Mallet *(Not depicted in kit picture)*

Used along with other instruments to facilitate applying the appropriate force for seating an abutment into the well of an implant, or an implant into an osteotomy. The mallet is also used with other instruments such as bone expanders or chisels.



Abutment Carrying Forceps *(Not depicted in kit picture)*

Designed to transport abutments and other components intraorally.



NOTE: The instrument tray may be sterilized at temperatures up to 273° F (134° C).

Pilot Drill Markings

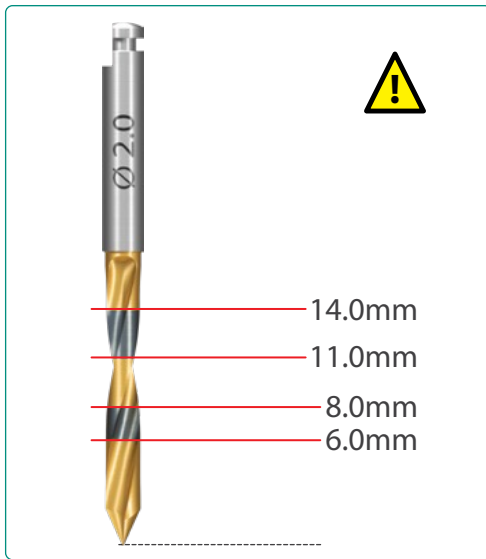

NOTE: PRIOR TO USING A PILOT DRILL, IT IS IMPERATIVE THAT ITS DEPTH MARKINGS ARE IDENTIFIED AND UNDERSTOOD.

NO ASSUMPTION SHOULD BE MADE ABOUT THE HEIGHT OF THE FIRST MARKING.

Drilling Depths

Once the appropriate trajectory of the 2.0mm pilot drill is confirmed, continue drilling to the appropriate depth. Bicon implants may be placed at varying depths depending upon the anatomy. The ideal positioning of a Bicon implant is 2.0–3.0mm below the crestal bone.

For optimal aesthetics in the anterior region, place the implant 5.0mm below the buccal gingiva.

For certain anatomically-challenging areas, implants may be placed at the crestal bone.

For immediately-placed implants in extraction sites, place the implant 4.0–5.0mm below the crestal bone to allow for some bone resorption.

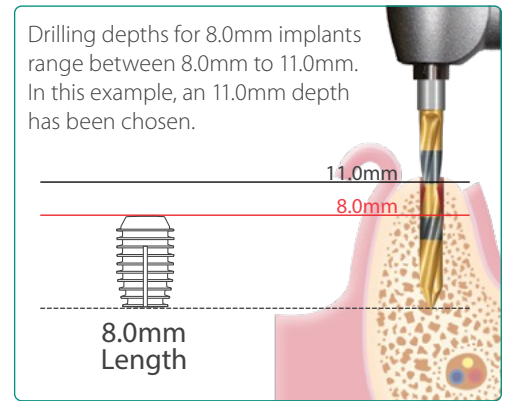
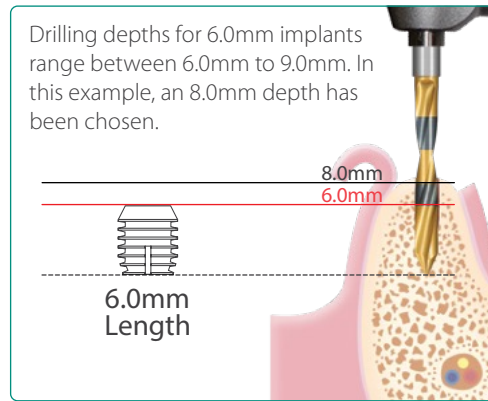
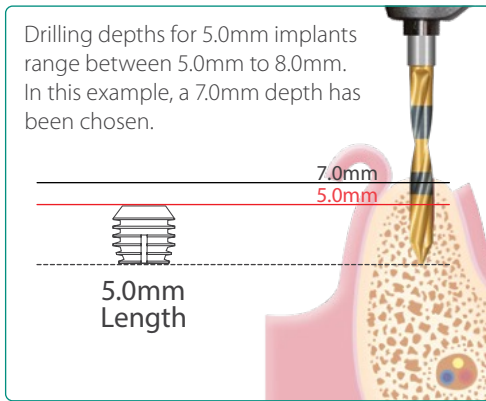

Pilot Drill Types and Indications

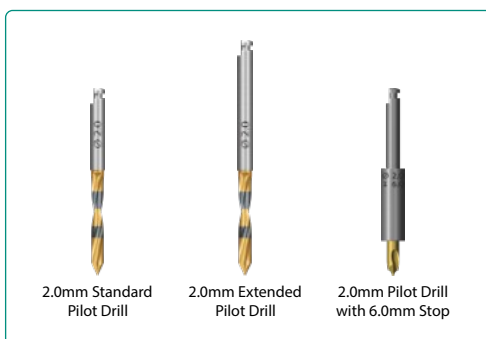

Standard Pilot Drill: The most commonly used pilot drill.

Extended Pilot Drill: Facilitates access when adjacent teeth interfere with the handpiece without having to use a latch extension.

Pilot Drill with Stops: When the anatomy permits — such as in cases with a flat and even ridge — pilot drills with stops can provide experienced and novice clinicians alike an extra layer of precision and confidence.

INSTRUMENTATION LATCH REAMERS

Latch Reamer Markings



After the pilot osteotomy has been prepared, the latch reamers are used sequentially beginning with a 2.5mm diameter and ending with the diameter of the intended implant. Latch reamers are color-coded according to their diameter and have horizontal markings at 6.0, 8.0, 11.0, and 14.0mm. **It is imperative that the depth indicators on the latch reamers are known and understood prior to their use. No assumptions should be made about the height of the first marking on any latch reamer.** If there is any doubt about the markings on any drill or reamer, take a measurement **prior** to using it.

NOTE: Latch reamers have a tapered and non-cutting tip. They are intended to only widen an osteotomy, and not to deepen it.

Latch Reaming Depths

Once the pilot osteotomy is completed, continue reaming to the appropriate depth. Bicon implants may be placed at varying depths depending upon the anatomy. The ideal positioning of a Bicon implant is 2.0–3.0mm below the crestal bone.

For optimal aesthetics in the anterior region, place the implant 5.0mm below the buccal gingiva.

For certain anatomically-challenging areas, implants may be placed at the crestal bone.

For immediately-placed implants in extraction sites, place the implant 4.0–5.0mm below the crestal bone to allow for some bone resorption.

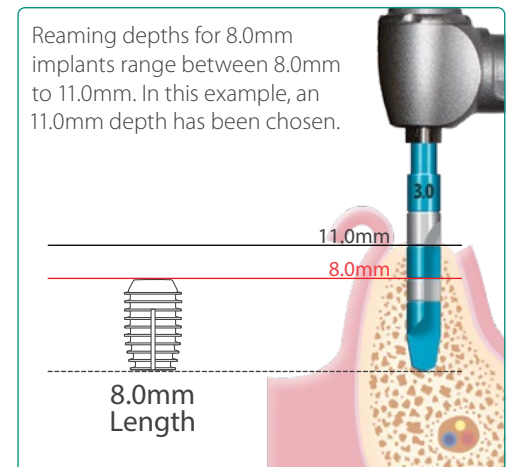
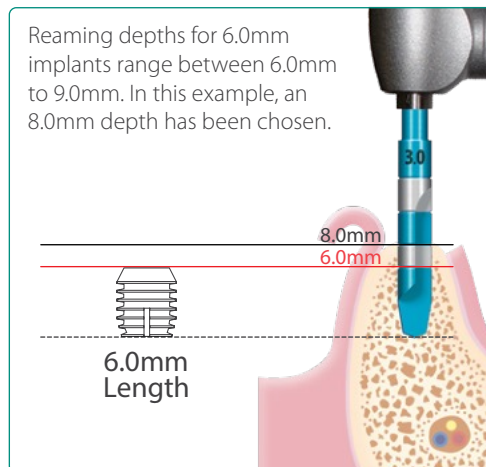
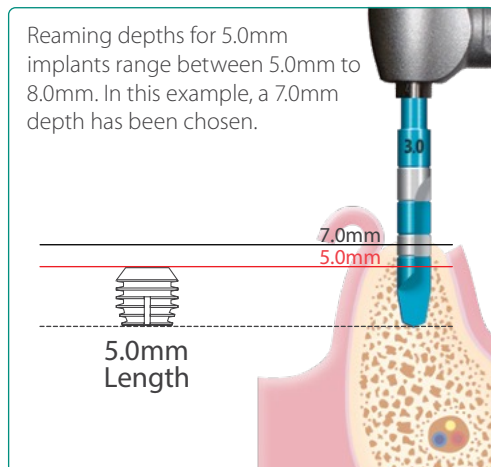

Hand Reamer Markings



After the pilot osteotomy has been prepared, the hand reamers are used sequentially beginning with a 2.5mm diameter and ending with the diameter of the intended implant. Hand reamers are color-coded according to their diameter and have horizontal markings at 6.0, 8.0, 11.0, and 14.0mm. **It is imperative that the depth indicators on the hand reamers are known and understood prior to their use. No assumptions should be made about the height of the first marking on any hand reamer.** If there is any doubt about the markings on any drill or reamer, take a measurement **prior** to using it.

Hand Reamers vs. Latch Reamers

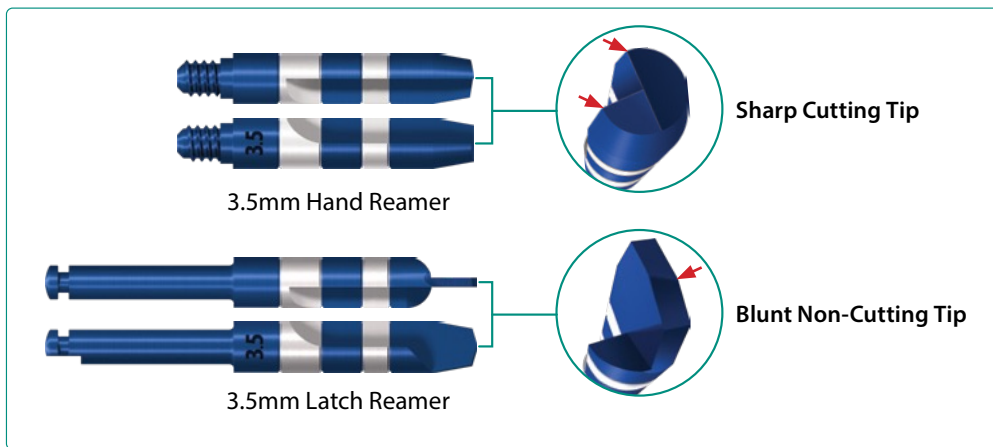

NOTE: Hand reamers have a sharp cutting tip and can both widen and deepen an osteotomy. Latch reamers have a tapered, non-cutting tip and are intended only to widen an osteotomy and not to deepen it.

A hand reamer can afford a high level of control when encountering challenging conditions such as thin facial bone or minimal bone between the osteotomy and adjacent teeth or implants. It can also be invaluable when working within the confines of a fresh maxillary anterior socket, in which the hand reamer can be used to enlarge the osteotomy by engaging only the palatal aspect of the socket while avoiding the fragile buccal wall.

Hand Reaming Depths

Once the pilot osteotomy is completed, continue reaming to the appropriate depth. Bicon implants may be placed at varying depths depending upon the anatomy. The ideal positioning of a Bicon implant is 2.0–3.0mm below the crestal bone.

For optimal aesthetics in the anterior region, place the implant 5.0mm below the buccal gingiva.

For certain anatomically-challenging areas, implants may be placed at the crestal bone.

For immediately-placed implants in extraction sites, place the implant 4.0–5.0mm below the crestal bone to allow for some bone resorption.

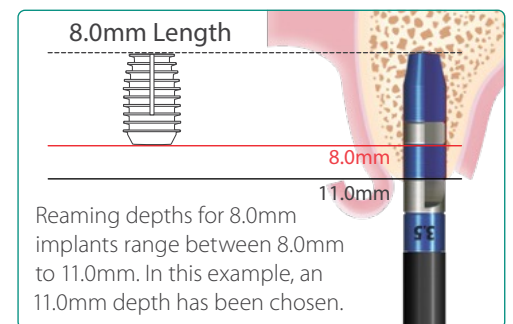
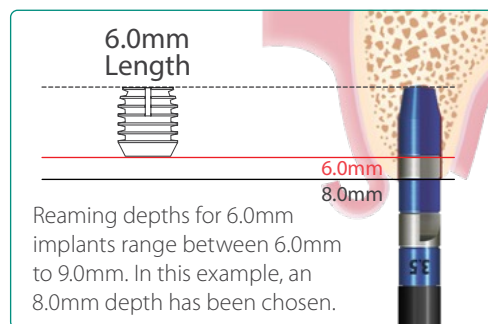
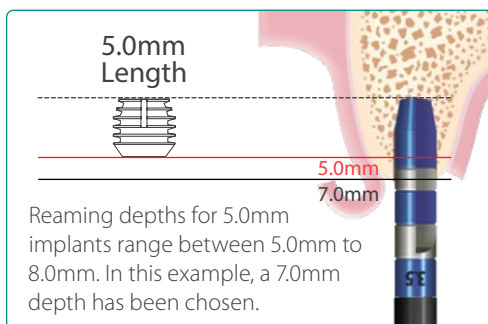

INSTRUMENTATION THREADED INSTRUMENTATION

Threaded Instrumentation Interchangeability

Bicon's threaded instrumentation offers interchangeability with threaded components. The Threaded Straight Handle can be used with all threaded components, while the Threaded Knob and Threaded Offset Handle can be used with some threaded components.

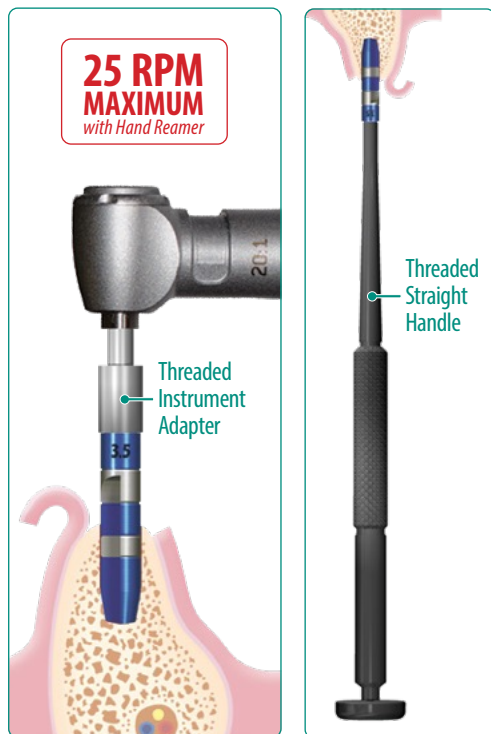
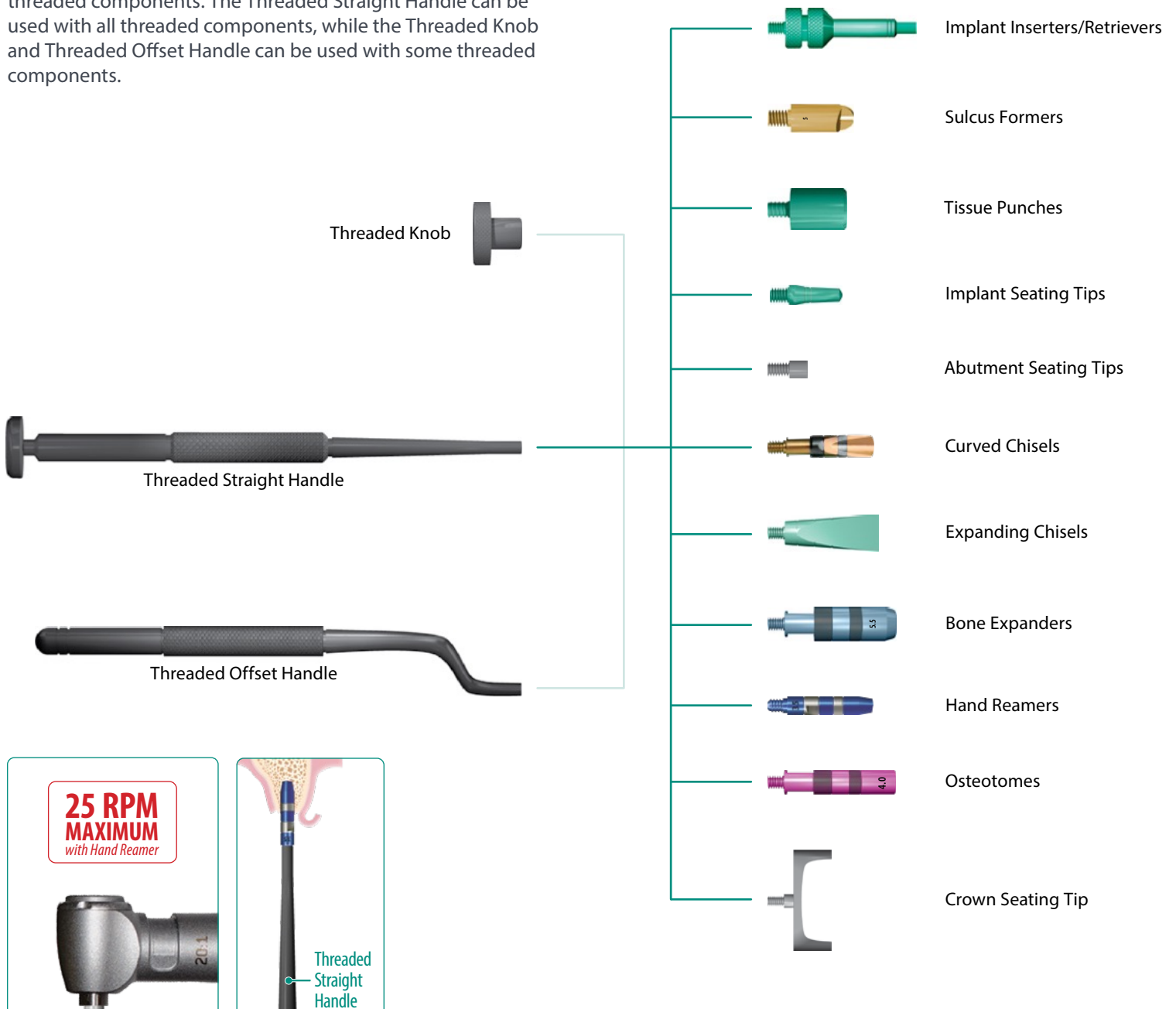

INTERCHANGEABILITY EXAMPLE: If a clinician chooses to use a hand reamer, there are options available depending upon the clinical situation or preference.

For the mandible, attach the hand reamer to a threaded instrument adapter and use with a latch contra-angle handpiece. **NOTE:** For this method, do not exceed 25 RPM.

For the maxilla, attach the hand reamer to a threaded straight handle.

Key Information on Implant Packaging



FRONT

- 1 QR code (part number and lot number)
- 2 Product part number
- 3 Manufacturing lot number
- 4 English product description
- 5 Use by date



INNER STERILE BLISTER PACK

- 1 Product part number
- 2 Do not use if package is damaged
- 3 English product description
- 4 Manufacturing lot number
- 5 Date of manufacture
- 6 Use by date

NOTE: Place label in patient's record.

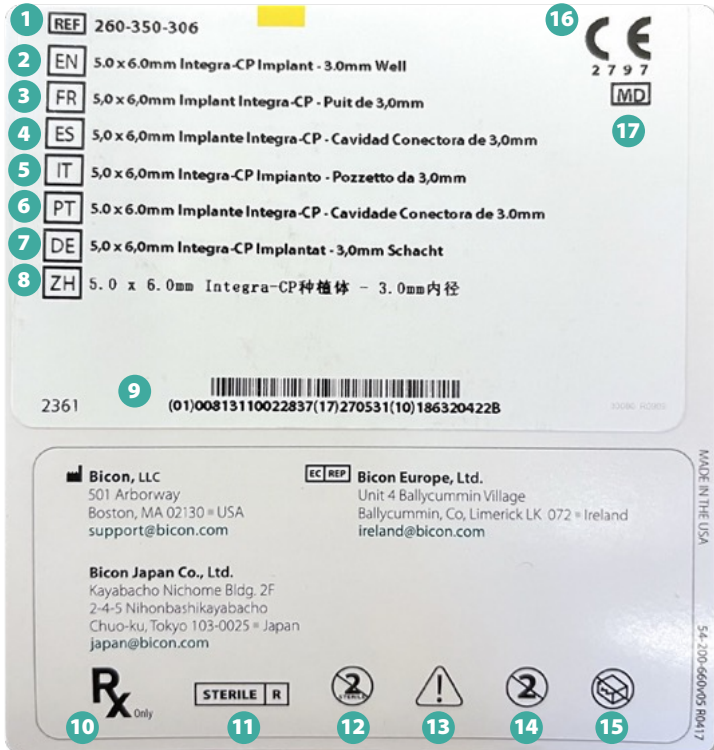

BACK

- 1 Product part number
- 2 English product description
- 3 French product description
- 4 Spanish product description
- 5 Italian product description
- 6 Portuguese product description
- 7 German product description
- 8 Chinese product description
- 9 Bar code (GTIN*, expiration date, and lot number)
- 10 By prescription only
- 11 Product is packaged sterile
- 12 Do not re-sterilize
- 13 Caution: read enclosed information
- 14 Single use only
- 15 Do not use if package is damaged
- 16 European CE Mark
- 17 Medical device

*Global Trade Item Number

IMPLANT BASICS TRANSPORTING IMPLANT

Removing Implant from Packaging

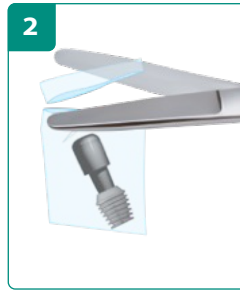

1. While wearing sterile gloves, the assistant removes the sterile Tyvek® blister pack from the cardboard folder, carefully peels back the Tyvek® backing of the blister pack, and allows the inner sterile poly bag to fall freely onto a sterile tray. Do not contaminate the poly bag. Place the label in the patient's record.
2. Cut the implant's inner sterile poly bag with a pair of sterile scissors.

Transporting Implant to Osteotomy with Healing Plug

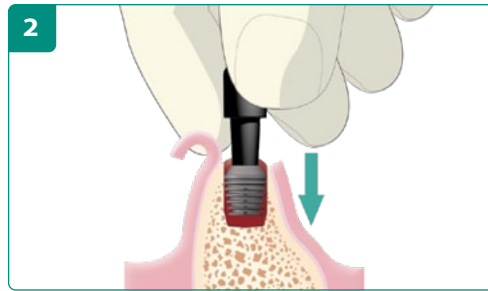
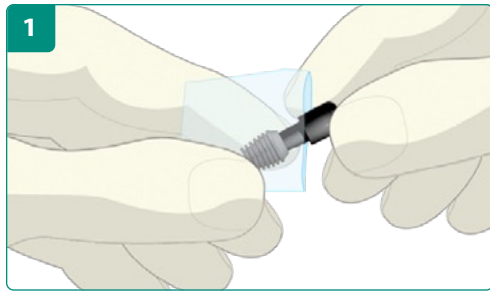

1. It is safe to hold the implant through the poly bag while wearing sterile gloves.
2. Remove implant from poly bag grasping the black healing plug, and place the implant into the osteotomy until it is stable.

Transporting Implant to Osteotomy with Implant Inserter/Retriever

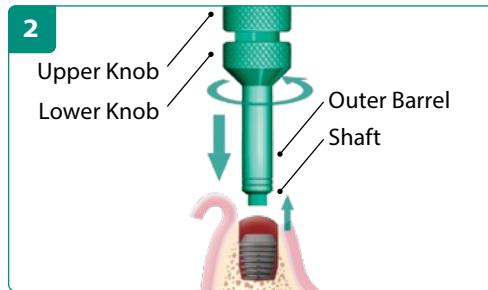
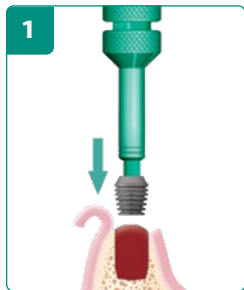

1. An implant inserter/retriever can be used to transport the implant to the osteotomy. Prior to using the implant inserter/retriever, a clinician should be familiar with how an implant is both attached to and dislodged from the instrument.
2. Grasp the upper knob on the implant inserter/retriever and rotate the lower knob counterclockwise. The outer barrel of the implant inserter/retriever will descend, gently pushing the implant off the shaft.

Single Tooth » Osteotomy Preparation and Implant Insertion • 5.0 x 6.0mm SHORT® Implant

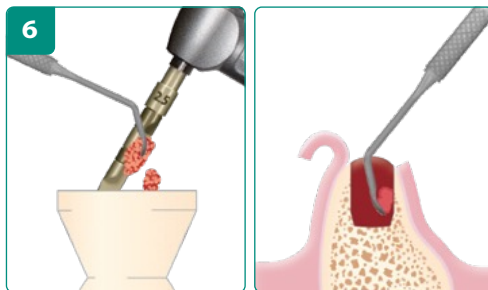
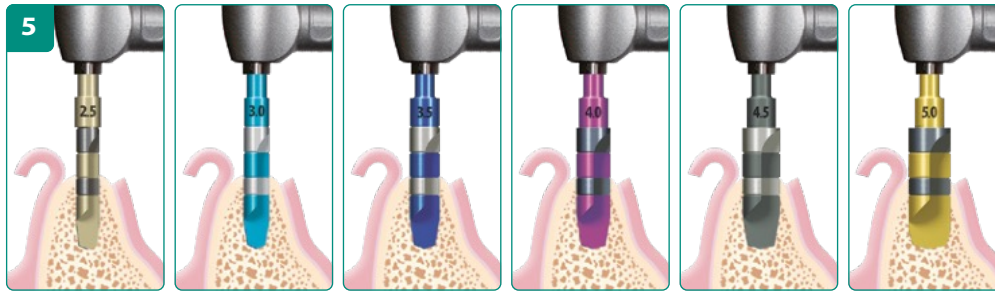
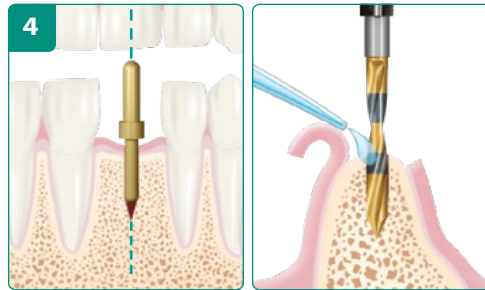
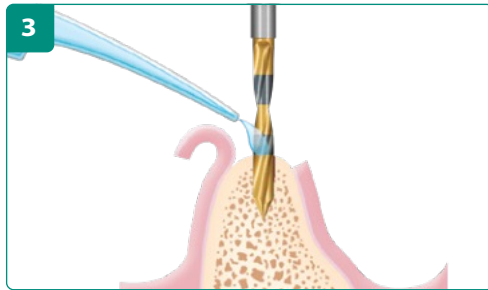
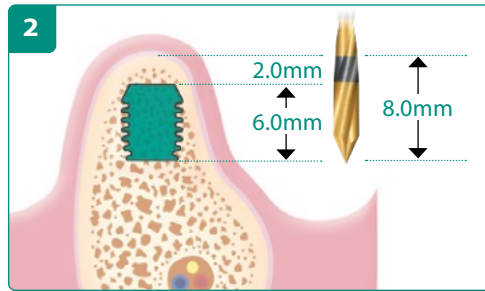
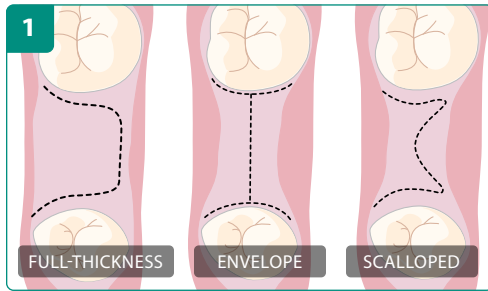

1. For the two-stage surgical technique, a full-thickness, envelope, or scalloped flap may be used depending on the clinician's preference.
2. PRIOR TO USING A PILOT DRILL, IT IS IMPERATIVE THAT ITS MARKINGS ARE IDENTIFIED AND UNDERSTOOD! Place the implant 2.0–3.0mm below the crest of bone. For this demonstration, we are placing a 5.0 x 6.0mm implant at an 8.0mm depth.
3. Drill 2.0mm pilot hole at 1,100 RPM with irrigation. Regardless of implant length, initially drill to only a depth of 6.0mm.
4. Use a paralleling pin to confirm trajectory of initial pilot hole, making sure the pin aligns with the opposing tooth. Then, drill the pilot hole to a depth 2.0–3.0mm deeper than the chosen implant when practical. In this demonstration, a final depth of 8.0mm was chosen.
5. Widen the osteotomy with sequentially wider reamers **without irrigation** at a maximum of 50 RPM. For this demonstration, a 5.0 x 6.0mm implant was selected so the final reamer has a diameter of 5.0mm.
6. Harvest autogenous bone intermittently from the flutes of the reamer burs and from osteotomy as it is progressively widened. Collect harvested bone into a silicone dappen dish and cover it with moist gauze for later use in Step 11.

Single Tooth » Osteotomy Preparation and Implant Insertion • 5.0 x 6.0mm SHORT® Implant (continued)

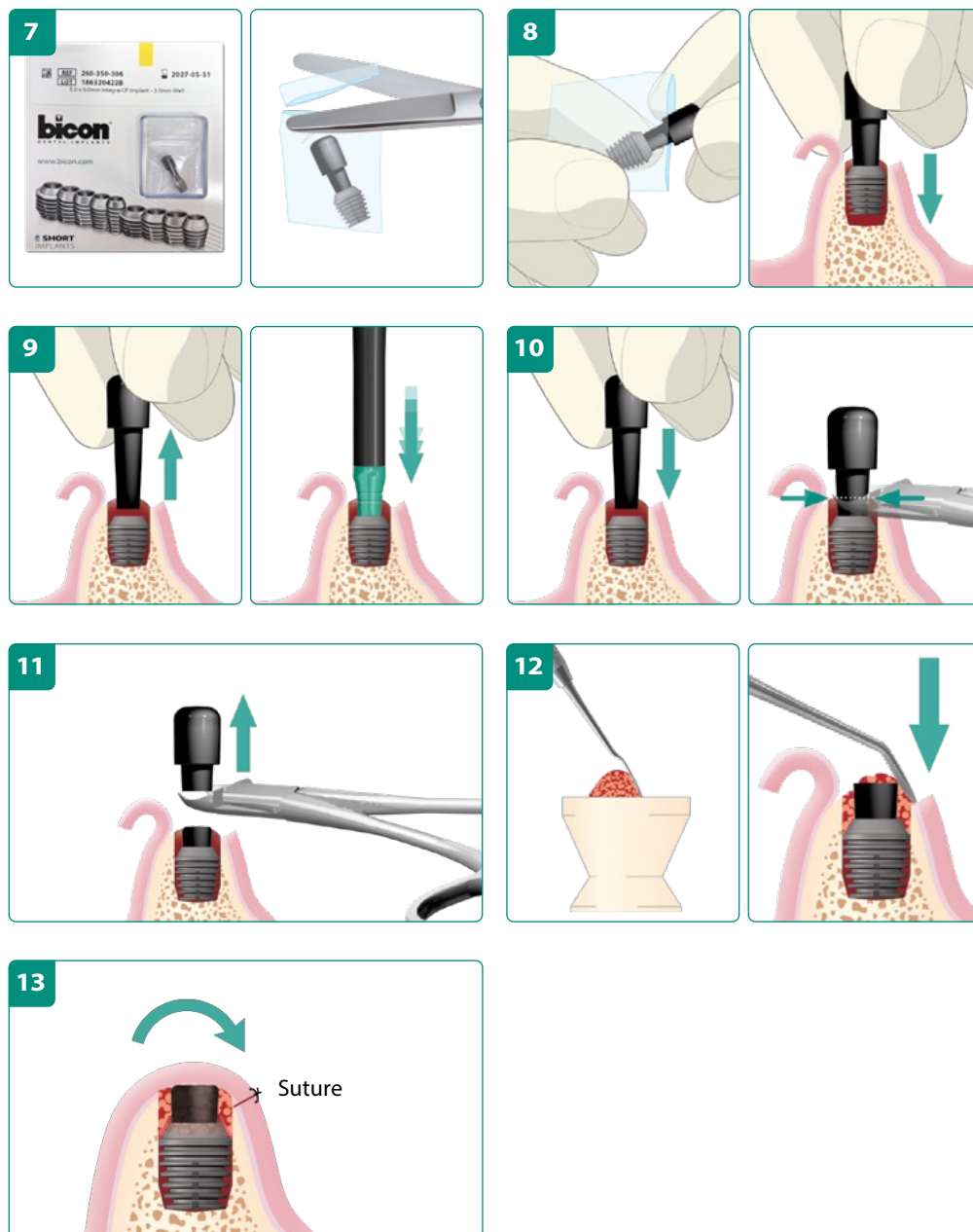

7. While wearing sterile gloves, the assistant removes the sterile Tyvek® blister pack from the cardboard folder, carefully peels back the Tyvek® backing of the blister pack, and allows the inner sterile poly bag to fall freely onto a sterile tray. Do not contaminate the poly bag. Place the label in the patient's record. Cut the implant's inner sterile poly bag with a pair of sterile scissors.
8. It is safe to hold the implant through the poly bag. Remove the implant from poly bag by grasping the black healing plug, and place the implant into the osteotomy until it is stable. Other methods of transporting an implant to the osteotomy are presented on Page 20.
9. In denser bone, it is often necessary to tap the implant into place. Remove the healing plug and tap with an appropriate implant seating tip attached to a threaded handle to be sure the implant is fully seated into the osteotomy.
10. Replace the healing plug, and gently mark the shaft intraorally at the crest of bone using the healing plug cutter.
11. Cut healing plug either extraorally or intraorally at the marked bone level above in Step 9. Cutting the plug extraorally affords the clinician the ability to remove any sharp edges from the cut healing plug that could irritate soft tissue. Then use a periodontal probe to transport the cut healing plug back into the implant well.
12. Using a Woodson or comparable instrument, place harvested bone from Step 6 over implant shoulder.
13. Close and wait a minimum of 3–4 months for osseointegration according to bone quality. For more information on bone quality, refer to page 5.

Single Tooth » Implant Uncovering and Abutment Placement • 5.0 x 6.0mm SHORT® Implant

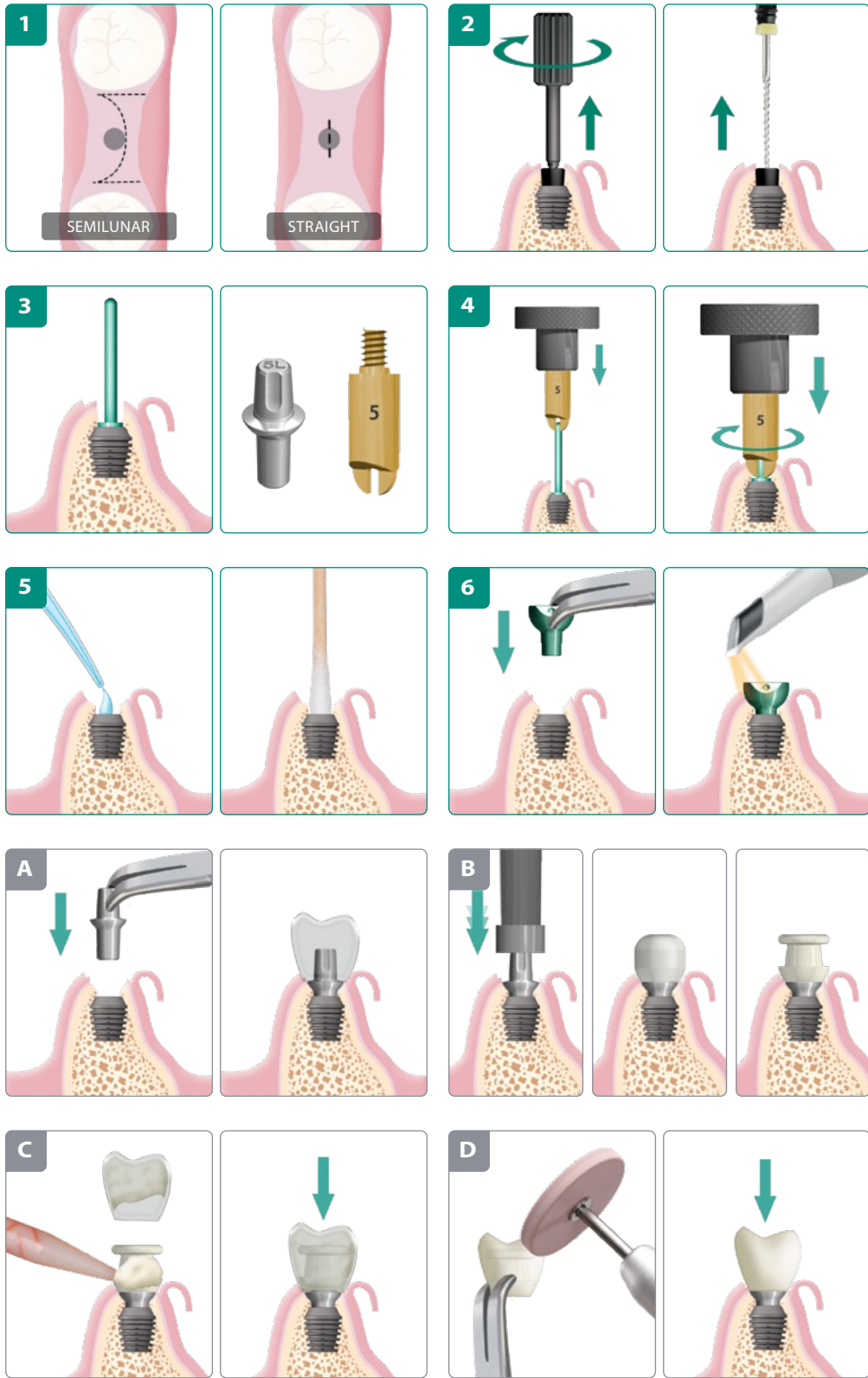

1. Expose the implant in aesthetic areas with a semilunar crestal incision. Other flap designs may be used for different areas or clinical situations.
2. Remove healing plug with a healing plug removal instrument. Alternatively, use a scaler or endodontic file.
3. Gently place appropriate guide pin to check integration and angulation. Select a sulcus former corresponding to the hemispherical base of the chosen abutment.
4. Slide sulcus former onto guide pin applying apical pressure. Remove excess bone with sulcus former attached to either threaded knob, straight handle, or threaded instrument adapter used with a handpiece.
5. Flush and clean the implant well of any debris with water. Dry the implant well with a cotton-tipped swab.
6. Insert the appropriate scannable temporary abutment according to the diameter of the implant well and intended abutment and scan it.
 - A. OPTION: Insert the selected abutment with light finger pressure only. Use a template to confirm appropriateness of abutment prior to engagement of locking taper connection.
 - B. Tap on abutment at least 3 times in long axis of abutment post to fully engage locking taper. Snap healing cap onto abutment, and, if necessary, replace flap and suture in place. **If you are creating a transitional prosthesis:** place temporization sleeve onto abutment and modify, if necessary, then proceed to next steps.
- C. Inject acrylic around temporization sleeve and into the template. Place template with acrylic to form transitional prosthesis.
- D. After polymerization, remove and polish acrylic and snap transitional prosthesis back in place to help form the gingival sulcus. Replace flap and suture in place, if necessary. Wait for soft tissue healing prior to taking final impression.

IMPLANT-LEVEL IMPRESSIONS

Conventional Implant-Level Impression

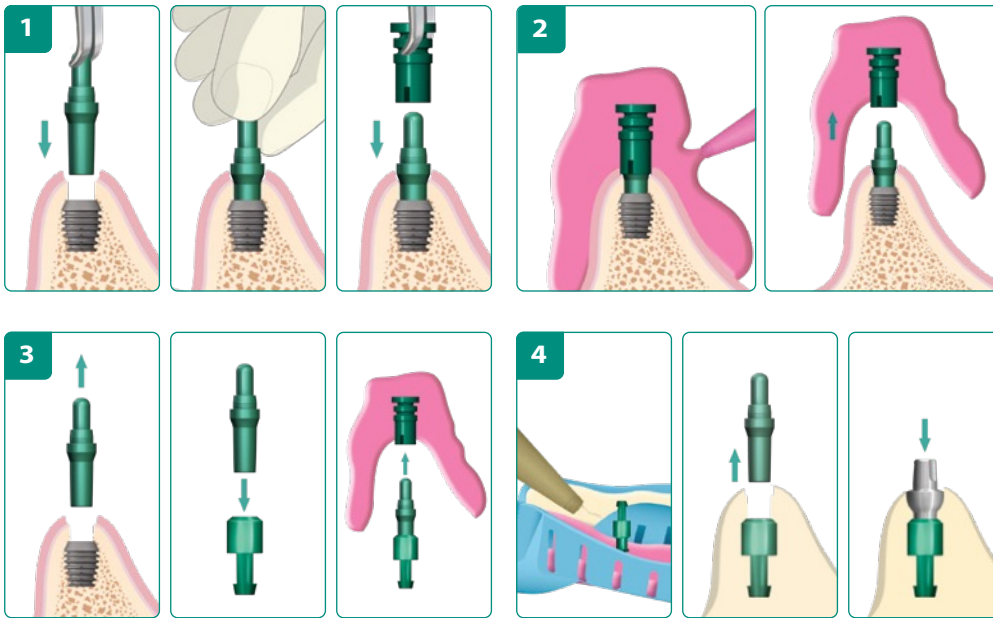

1. Insert the corresponding diameter metal impression post into the well of the implant with only finger pressure. Snap the corresponding plastic impression sleeve onto metal post.
2. Inject impression material around the plastic sleeve. After the impression has set, remove the impression with the sleeve within it. If the metal impression post is dislodged with the sleeve, repeat the impression since the axial position of the implant may not have been accurately recorded.
3. Remove metal post from implant and insert it into a corresponding implant analog, prior to inserting them as a unit into the plastic sleeve within the impression for the pouring of a stone model.
4. The laboratory pours a soft tissue model and selects the widest diameter permanent abutment that supports the interdental papillae without encroaching upon them.

Note color coding of impression components:

- 2.0 2.0mm Well
 ● 2.5 2.5mm Well
 ● 3.0 3.0mm Well

Digital Implant-Level Impression with a Digital Scan Post

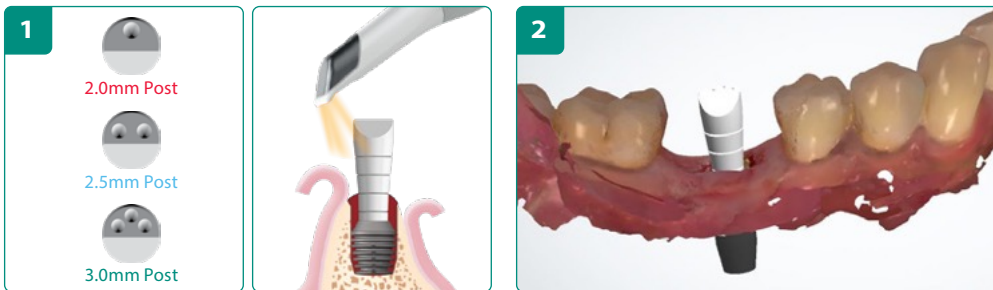

1. Insert digital scan post corresponding to the diameter of the implant well and scan it. The dimples designate the post/well diameter.
2. Design and fabricate the final restoration with the CAD/CAM software of your choice.

Digital Implant-Level Impression with a Scannable Temporary Abutment



1. Insert the appropriate scannable temporary abutment according to the diameter of the implant well and final abutment and scan it. The dimples and color designate the post/well diameter and the laser marking designates the abutment diameter and height.
2. Design and fabricate the final restoration with the CAD/CAM software of your choice.

NOTE: For Abutment-Level Impressions, please see the Bicon Restorative Manual.

Single Tooth » Osteotomy Preparation and Implant/Abutment Insertion • 5.0 x 6.0mm SHORT® Implant

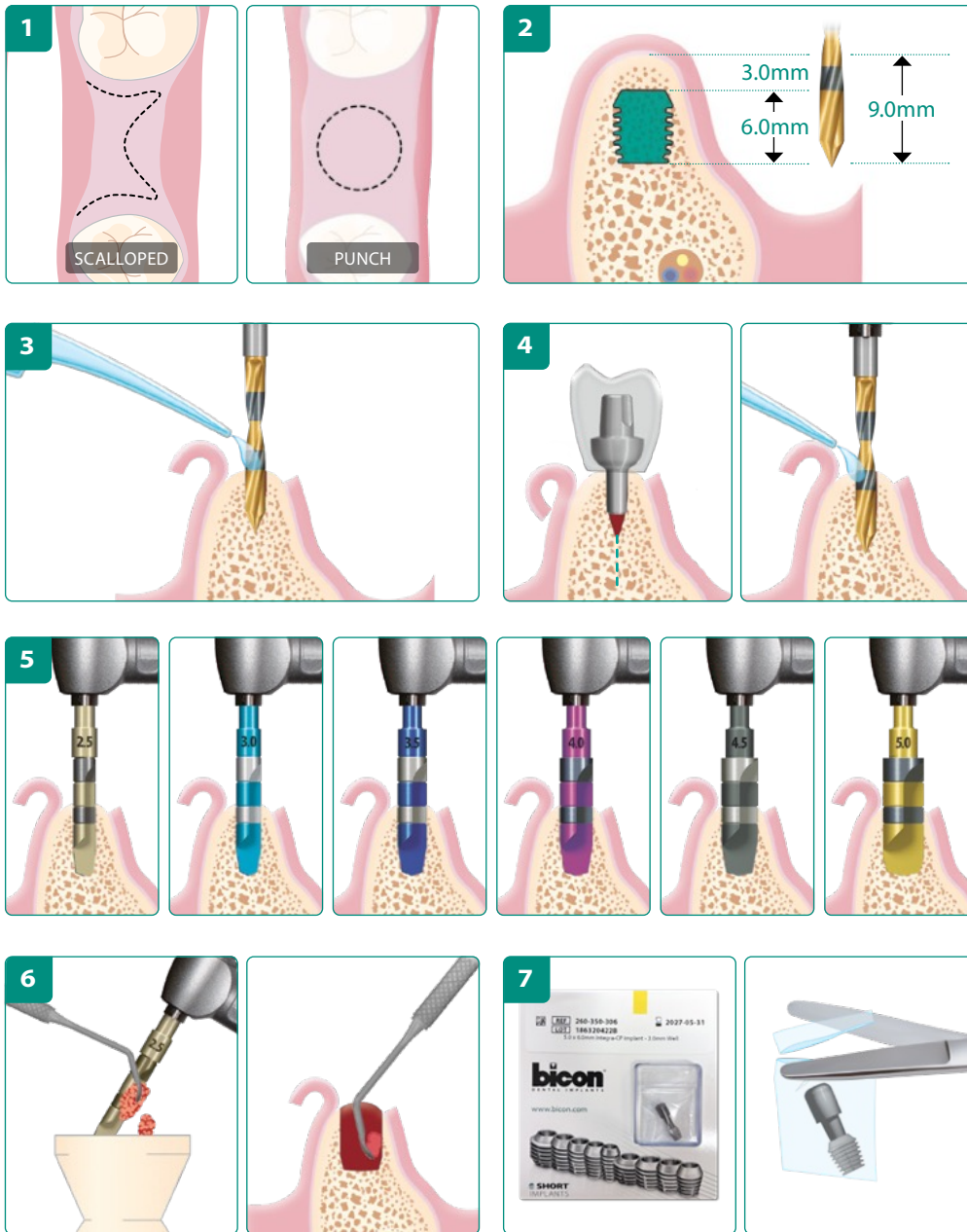

1. For the one-stage surgical technique, a scalloped or punch flap may be used for non-extraction sites.
2. PRIOR TO USING A PILOT DRILL, IT IS IMPERATIVE THAT ITS MARKINGS ARE IDENTIFIED AND UNDERSTOOD! For the one-stage technique, place the implant 3.0mm below the crest of bone. For this demonstration, we are placing a 5.0 x 6.0mm implant at a 9.0mm depth.
3. Drill 2.0mm pilot hole at 1,100 RPM with irrigation. Regardless of the intended implant length, initially drill to only a depth of 6.0mm.
4. It may be helpful to place an abutment with a 2.0mm post into pilot hole and confirm appropriateness with a vacu-press template. Once confirmed, drill the pilot hole to a depth 3.0mm deeper than the chosen implant when practical, in this demonstration a final depth of 9.0mm.
5. Widen the osteotomy with sequentially wider reamers **without irrigation** at a maximum of 50 RPM. For this demonstration, a 5.0 x 6.0mm implant was selected so the final reamer has a diameter of 5.0mm.
6. Harvest autogenous bone intermittently from the flutes of the reamer burs and from osteotomy as it is progressively widened. Collect harvested bone into a silicone dappen dish and cover it with moist gauze for later use in Step 14.
7. While wearing sterile gloves, the assistant removes the sterile Tyvek® blister pack from the cardboard folder, carefully peels back the Tyvek® backing of the blister pack, and allows the inner sterile poly bag to fall freely onto a sterile tray. Do not contaminate the poly bag. Place the label in the patient's record. Cut the implant's inner sterile poly bag with a pair of sterile scissors.

Single Tooth » Osteotomy Preparation and Implant/Abutment Insertion • 5.0 x 6.0mm SHORT® Implant (continued)

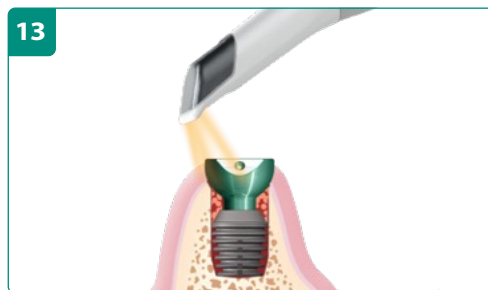
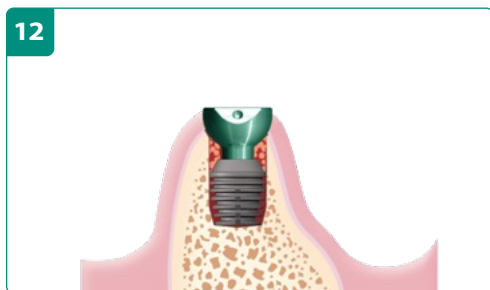
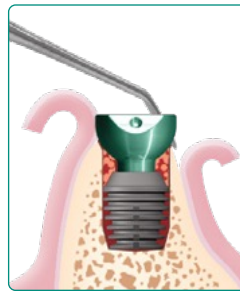
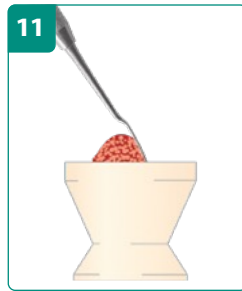
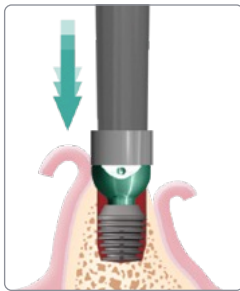
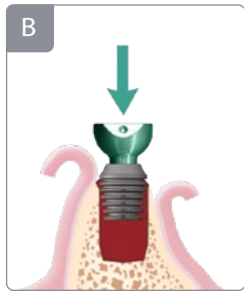
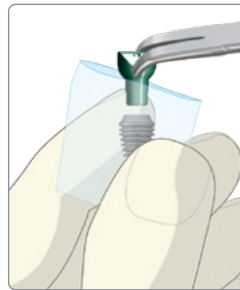
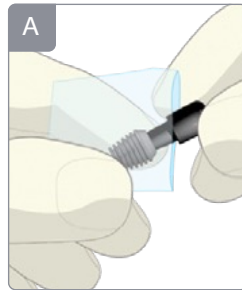
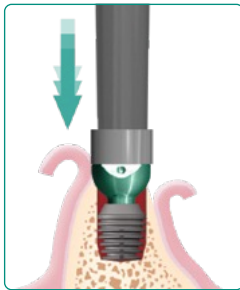
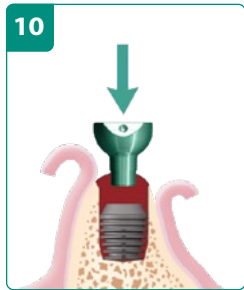
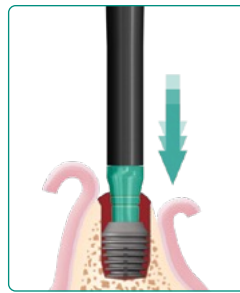
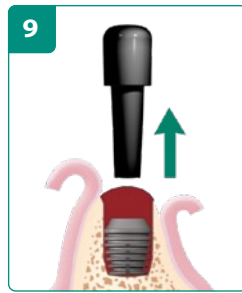
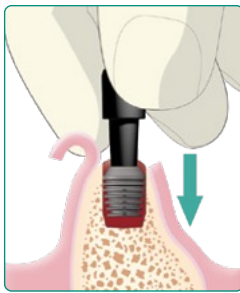
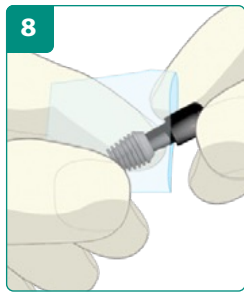

- 8.** It is safe to hold the implant through the poly bag. Remove implant from poly bag by grasping the black healing plug, and place the implant into the osteotomy until it is stable. If necessary, tap the implant to seat it fully. Methods of transporting an implant to the osteotomy are presented on Page 20.
- 9.** In denser bone, it is often required to tap the implant into place. Remove the healing plug and tap with an appropriate implant seating tip attached to a threaded handle to be sure the implant is fully seated into the osteotomy.
- 10.** Place appropriate scannable temporary abutment into the implant. Gently tap on abutment to engage locking taper. Proceed to Step 11.
- A.** OPTION: Alternatively to Steps 8-10, remove the black healing plug from the implant and replace it with an appropriate scannable temporary abutment.
- B.** Insert implant with scannable temporary abutment into osteotomy as a unit. Gently tap on abutment to engage locking taper. During this step, some clinicians prefer to place harvested bone or PRF (platelet-rich fibrin) graft between the abutment and implant prior to inserting them into the osteotomy as a unit.
- 11.** Using a Woodson or comparable instrument, carefully place harvested bone from Step 6 over implant shoulder.
- 12.** Trim excess tissue, if necessary. Wait for a minimum of 3–4 months for osseointegration before removing scannable temporary abutment.
- 13.** At this point or at any time during osseointegration, you can scan the scannable temporary abutment for the fabrication of the final restoration, reducing chairtime and patient visits.

GUIDED SURGERY

Guided surgery can be an effective and efficient surgical technique if there is ample bone, especially for novice implant clinicians.

It is important to definitively stabilize the CBCT-designed surgical guide on the remaining teeth or with screws fastened to the bone.

Many experienced clinicians prefer to use CBCT-designed surgical guides for use with the Guided Pilot Drill only, especially where there is minimal bone available. This affords the opportunity to use various techniques, such as ridge widening and internal sinus lift procedures, which are the hallmark of Bicon's hand reamers and surgical protocols.

5.0mm Guided Surgery Kit

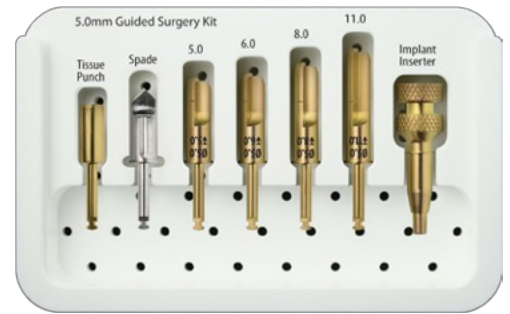

Single Tooth » Guided Osteotomy Preparation and Implant Placement • 5.0 x 6.0mm Implant

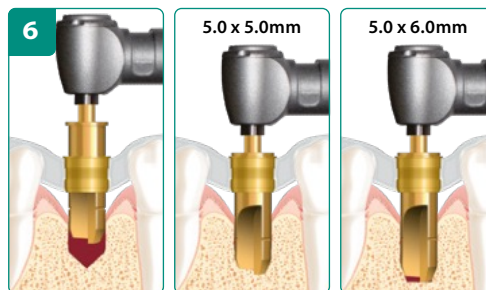
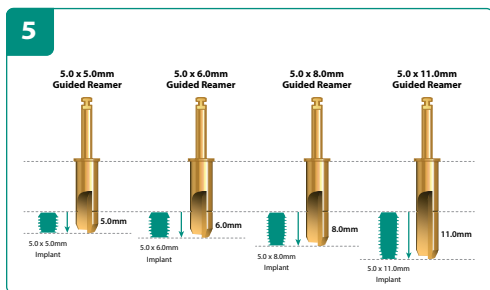
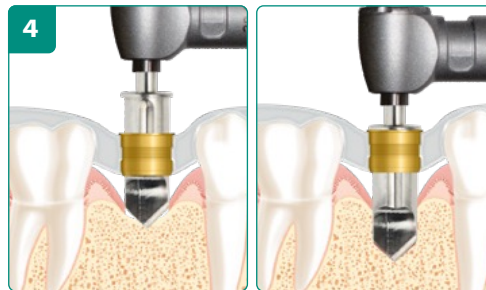
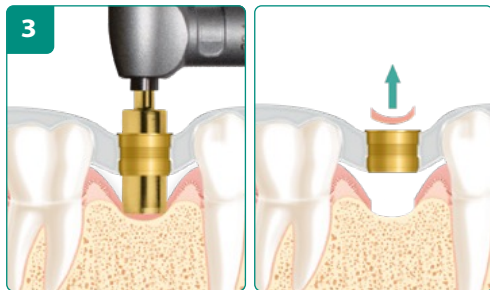
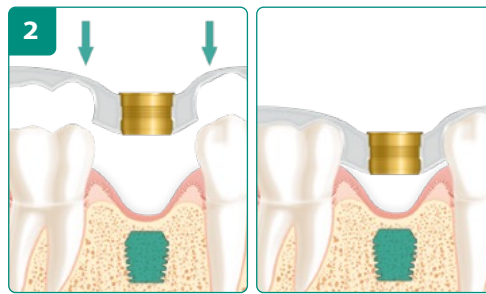
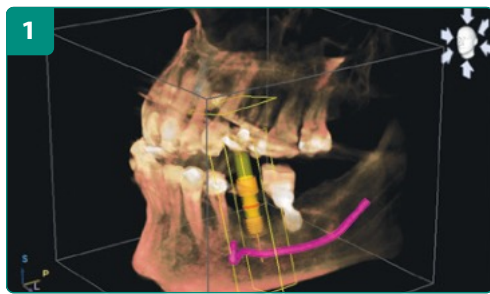

1. With a CBCT scan, choose an appropriate Bicon implant from the software, and position it so that it lies parallel with the adjacent teeth to allow for the use of a straight abutment. After finalizing the design, send the scan to a guide-fabricating laboratory.
2. Place the guide over the adjacent teeth and verify its fit and stability before proceeding. Note the intended implant placement and the 5.0mm color-coded guide ring embedded within the guide.
3. Use the guided tissue punch to remove a circular piece of mucosa and keep it moist so that it may be replaced. Alternatively, use the guided tissue punch to mark the osteotomy site and then create a flap with a scalpel.
4. Use the guided spade drill rotating at 400 RPM with irrigation to create the initial osteotomy. The drill is advanced into the osteotomy until it contacts the color-coded ring. When the cortical bone is dense, one should initially use a standard pilot drill to penetrate the cortical bone and then proceed with the guided spade drill.
5. To deepen the osteotomy, use the guided reamers sequentially until the final intended implant length is achieved.
6. For the depicted 5.0 x 6.0mm implant placement, start with the 5.0 x 5.0mm guided reamer and finish with the 5.0 x 6.0mm guided reamer. Rotate the reamers at 50 RPM without irrigation and harvest autogenous bone as it accumulates within the reamer flute.

Single Tooth » Guided Osteotomy Preparation and Implant Placement • 5.0 x 6.0mm Implant (continued)

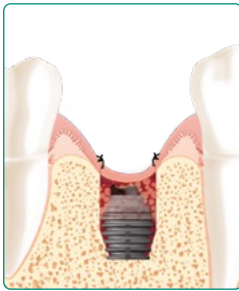
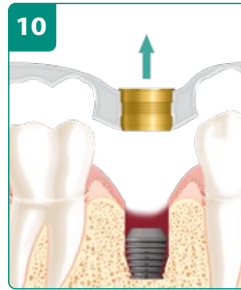
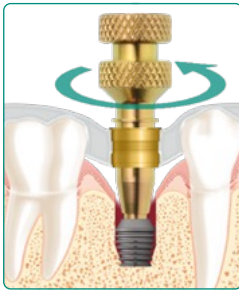
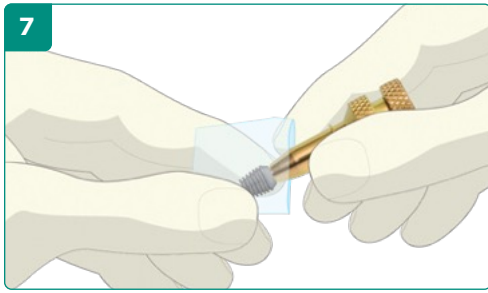

- 7.** Open the sterile implant packaging, remove healing plug, and place guided inserter into implant and rotate the lower knob counterclockwise until it is flush with the top of the implant.
- 8.** Note that the guided inserter should sit flush with the top of the implant prior to insertion.
- 9.** Place the guided inserter through the guide and rotate the lower knob counterclockwise to disengage the implant.
- 10.** Remove the guide, and place a cut healing plug into the well of the implant.
- 11.** Using a Woodson or comparable instrument, carefully place harvested bone from Step 6 over the implant shoulder. Replace the circular piece of mucosa or flap and suture in place. Wait for a minimum of 3–4 months for osseointegration.

Guided Surgery Sequence Planning for a 5.0 x 6.0mm Implant

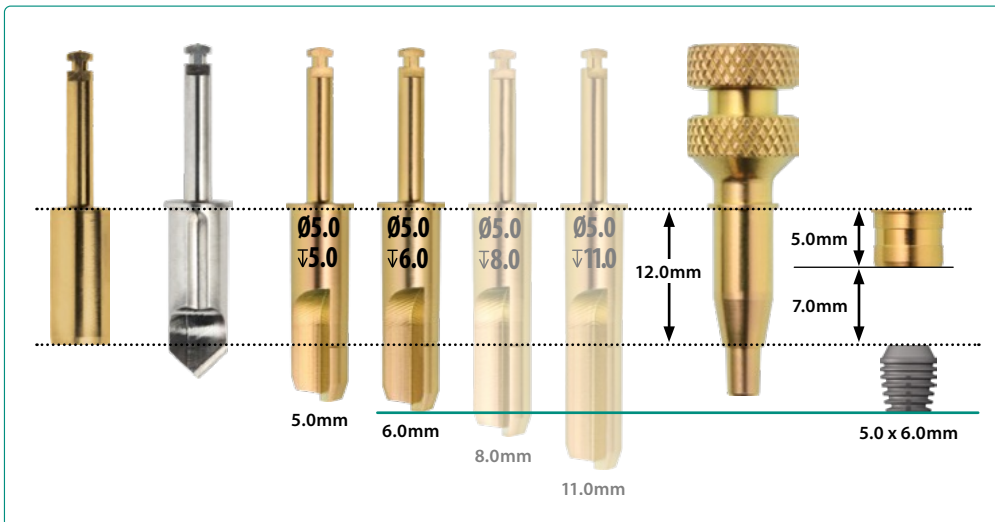

Single Tooth » Osteotomy Preparation and Implant Insertion • 5.0 x 6.0mm SHORT® Implant

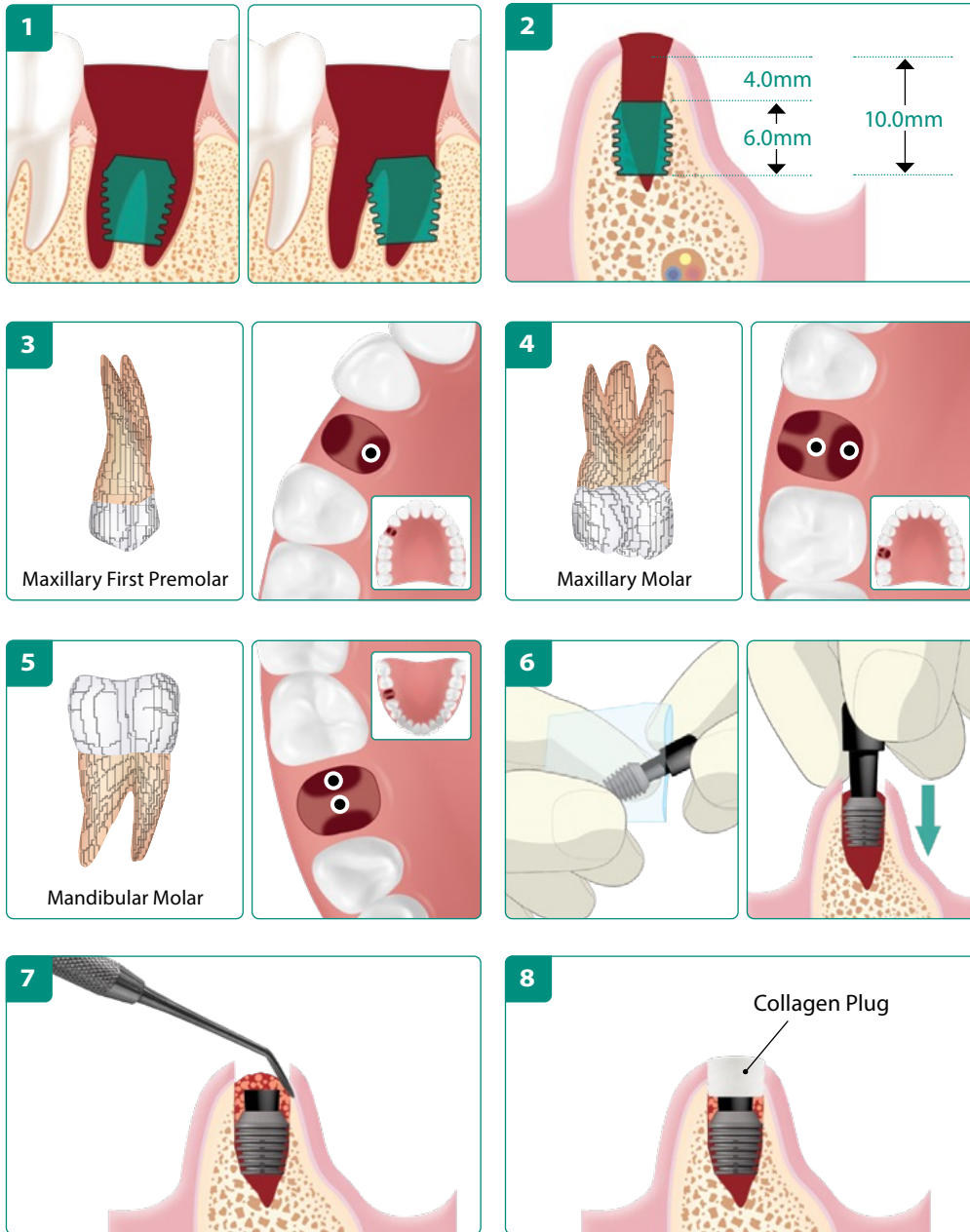

The immediate placement of Bicon implants into extraction sites using the one or two-stage technique is a very practical and successful technique. However, it may not be prudent for inexperienced clinicians to do so until they have mastered some of the nuances of placing Bicon implants, especially in sites with a furcation.

Experienced clinicians vary significantly in their preferred techniques. The following considerations may be helpful:

1. For sites with a furcation, the anatomy of available bone dictates whether to place the implant in the septal bone of the furcation site or a root socket.
2. Place the implant 4.0–5.0mm below the crest of bone to allow for bone resorption.
3. For a maxillary first premolar, place in the palatal socket using the one or two-stage technique.
4. For a maxillary molar, preferably place in the septal bone of the trifurcation site or alternatively in the palatal root using the one or two-stage technique. Use hand reamers or osteotomes to facilitate centering the implant's trajectory.
5. For a mandibular molar, place in the septal bone of the bifurcation site or distal root using the one or two-stage technique. Use hand reamers or osteotomes to facilitate centering the implant's trajectory.
6. Transport and insert implant as described on page 20. Cut healing plug at an appropriate level as depicted in Steps 9–10 on Page 22.
7. Place harvested bone or SynthoGraft® over the implant. There is no need to graft the root sockets.
8. Cover the site with a Collagen Plug or PRF (platelet-rich fibrin) graft. Some clinicians prefer to use the periosteum of a split-thickness flap (envelope flap), a Scannable Temporary Abutment, or a Sinus Lift Abutment.

SURGICAL TIPS

Drilling on a Slope

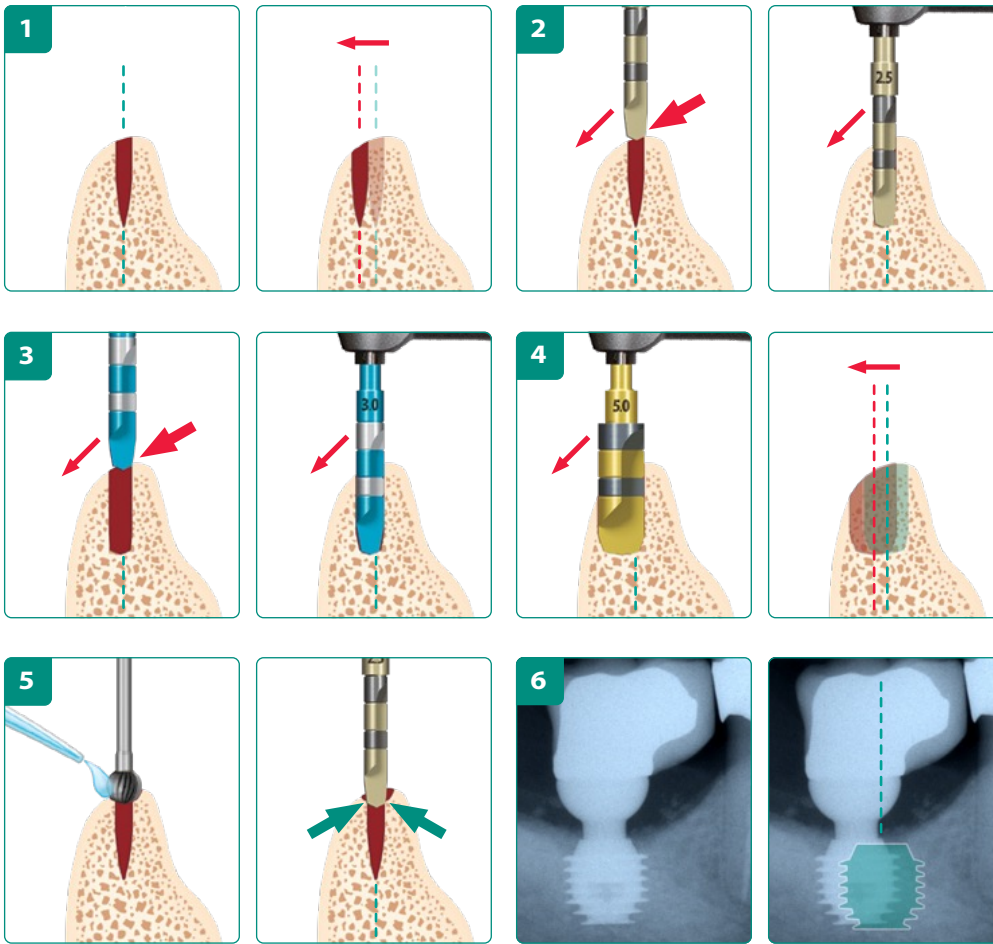

While reaming on a slope, reamers can inadvertently move lower on the slope, which is usually distally or buccally. Additionally, reamers inadvertently move away from more dense bone, which is usually from the palatal or lingual bone toward the buccal.

1. The pilot osteotomy should be positioned in the middle of the edentulous space which usually aligns with the opposing tooth. To facilitate this positioning and avoid parallax, view the pilot drill from both sides of the patient. A poorly positioned osteotomy may result in the need to use an angled abutment, malocclusion, or a crown with a cantilever.
2. Because the reamers have a beveled tip, contacting the higher bone on one side inadvertently moves the reamer and the osteotomy away from the higher bone of the slope.
3. This downhill drift can continue with each successive reamer.
4. This can continue until the final reamer, resulting in an osteotomy that is off center from the initial pilot hole.
5. To avoid this, briefly and gently use a 4.0mm round bur at high speed to form a countersink at the orifice of the pilot hole. This "funnel" shape allows the reamer to contact bone on both sides simultaneously and guides the reamer into the center of the pilot hole.
6. The lingual to buccal drift depicted in the preceding steps can also occur from mesial to distal. Note the crown with a mesial cantilever and the intended implant placement.

Drilling in a Maxillary Anterior Extraction Site

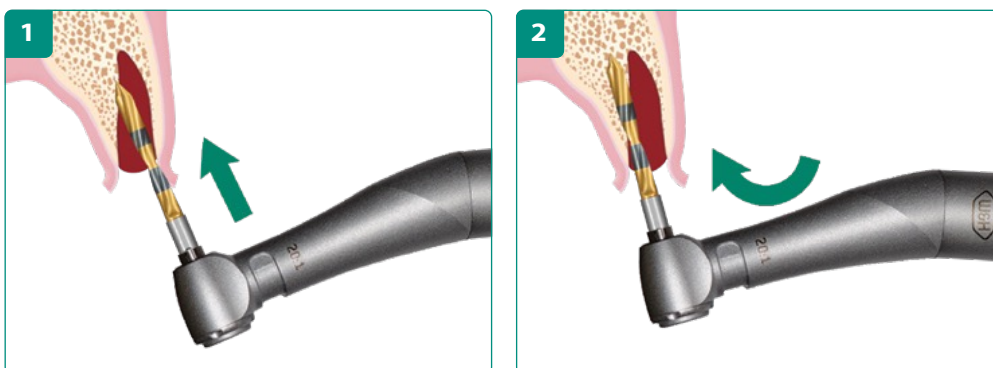

1. Initially drill with the pilot drill palatally 3.0–4.0mm coronally to the apex of the extraction socket. This initial angulation can vary between 25° and 45° depending upon the clinical situation.
2. Immediately upon the pilot drill's engagement of the bone, change the drill's trajectory to be more parallel with the adjacent teeth and the proposed restoration.



WORLD HEADQUARTERS

501 Arborway

Boston, MA 02130 USA

TEL 800.88.BICON ■ 617.524.4443

FAX 800.28.BICON ■ 617.524.0096

www.bicon.com ■ support@bicon.com

bicon[®]
DENTAL IMPLANTS